

INSTALLATION MANUAL

PRODUCT: ENGINE SKID PLATE

APPLICATION: MERCEDES BENZ SPRINTER (2023-)

PART NO: 2333.3961.1.6

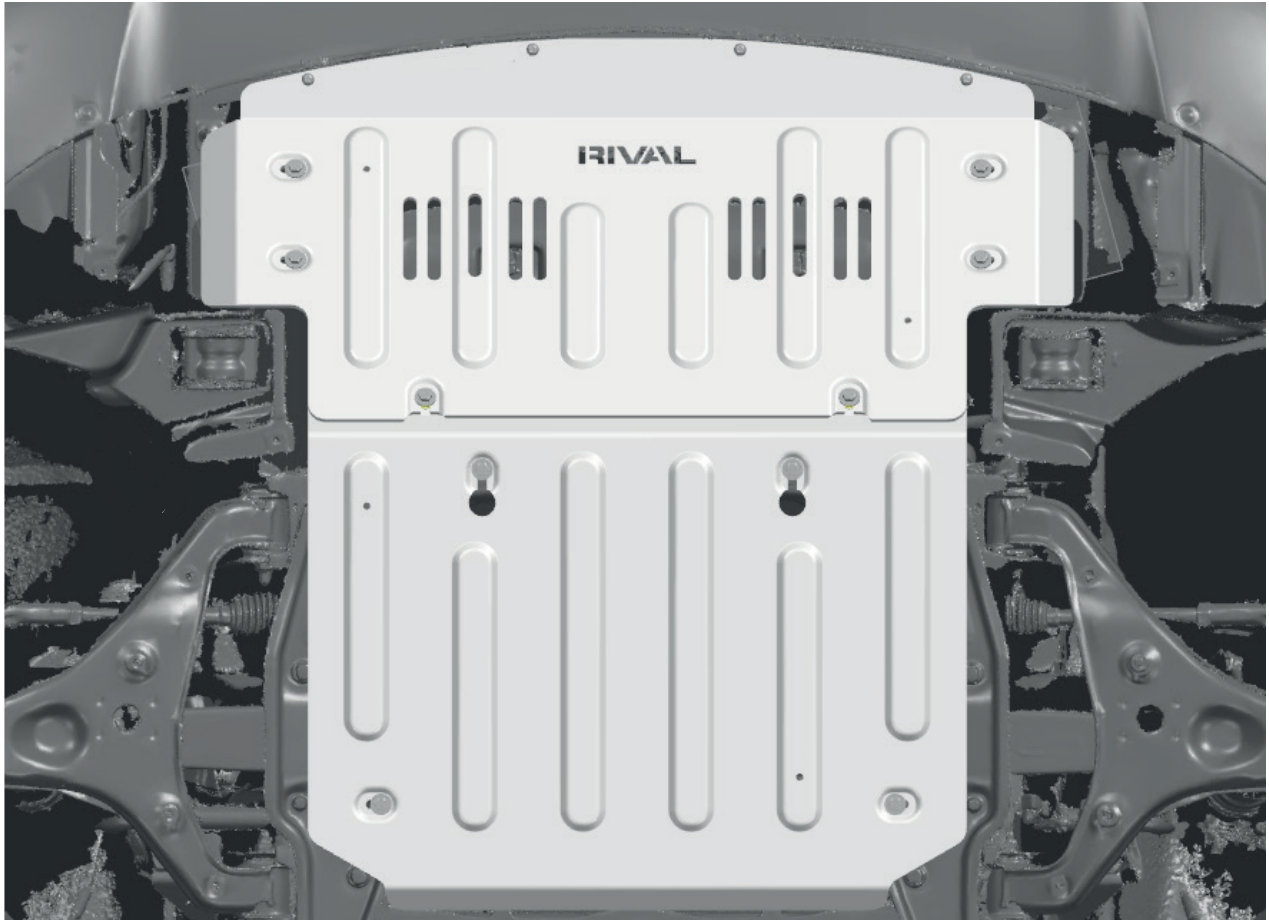

CAUTION!

To reduce the risk of serious injury or damage to property: Before you start installing and using this product, read the full instructions, pay special attention to the conditions of safe use and recommendations for installation! When installing or maintaining this product, it is necessary to use protective goggles. Check the integrity of the structure and the moment the fastening is tightened every 250 miles (400 kms) of mileage. Do not use this product if there is damage to the structure or fasteners!

NOTICE

Skid plate is an additional protection, but it can not guarantee to protect against all possible damage in collisions. When driving, be careful of objects and terrain that may damage sensitive parts of the vehicle.

ENGINE SKID PLATE



Part number 2333.3961.1.6

Suited to vehicle: MERCEDES BENZ SPRINTER V-2.1D; AT; 4WD (2023-)

Material: Aluminum



SAFETY NOTICE

- * The RIVAL engine skid plate is designed to complement the use and design of the specified vehicle under conditions specified by the vehicle manufacturer.
- * While driving the vehicle at any speed, collision with any other vehicle, animal or object must always be avoided.
- * Following any collision with any other vehicle, animal or object, the RIVAL engine skid plate and the vehicle must be inspected by a specialized or suitably qualified vehicle repairer for possible damage to the components and assemblies in order to confirm suitability for further use of the vehicle.
- * It is strongly recommended that you do not operate a vehicle with a damaged engine skid plate or its components. In the case of damage, please contact the nearest RIVAL dealer. Vehicle, or where the skid plate has been damaged, is extremely dangerous and must be avoided at all cost.

INSTALLATION NOTICE

- * The RIVAL engine skid plate must be mounted and affixed to the vehicle according to this installation manual.
- * Personal safety during the installation process must be adhered to at all times.
- * Do not install this skid plate on vehicle models other than those allowed in this manual.
- * Estimated time for installation: 1 hour.

REQUIRED TOOLS

- * Basic tool kit
- * Torque wrench

TORQUE SETTING

- * M8 - 24 H·m (17.7 lb/ft)

PARTS LISTING

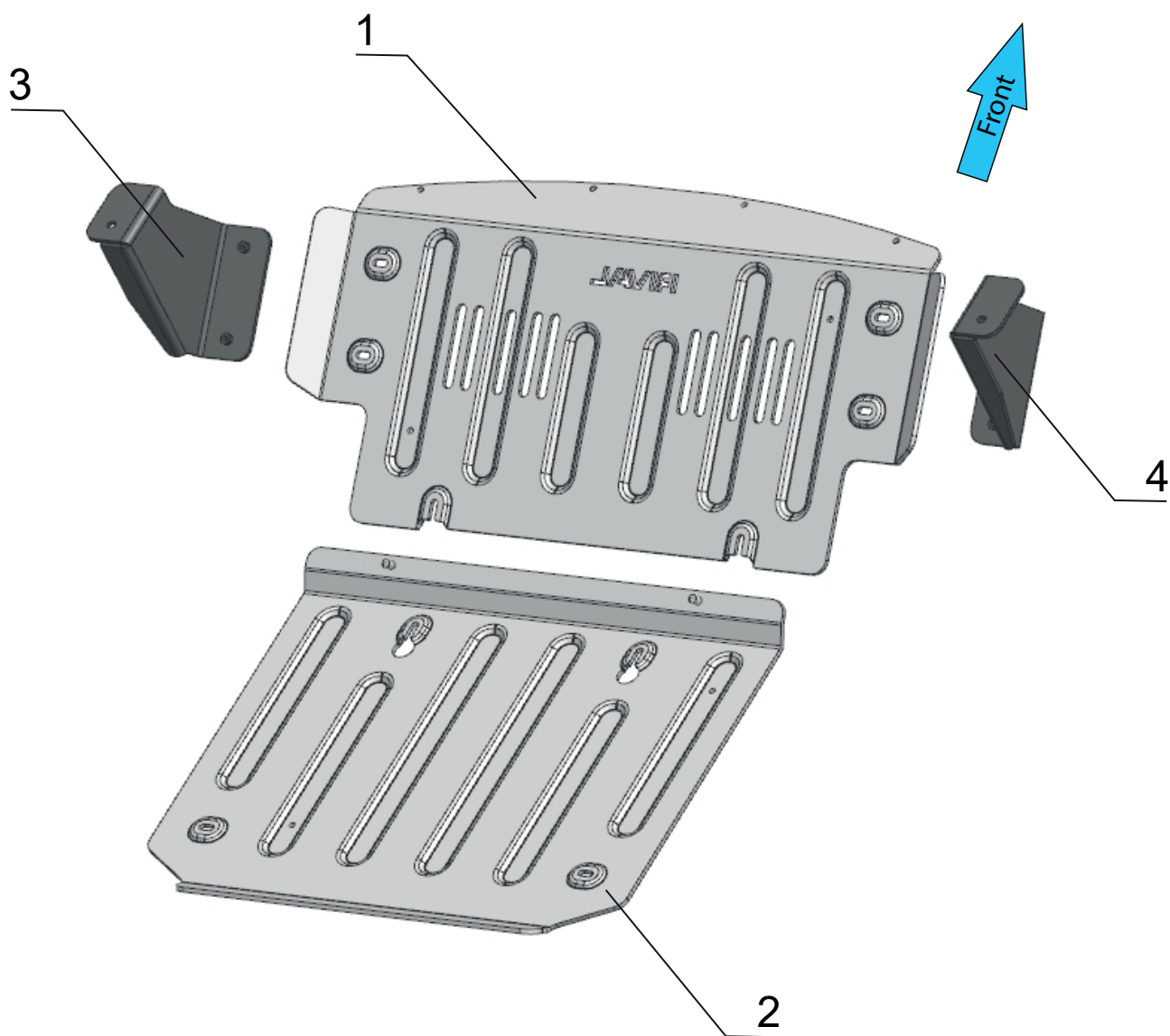

- 1. Engine skid plate 1.....Qty 1
- 2. Engine skid plate 2.....Qty 1
- 3. Mount bracket left.....Qty 1
- 4. Mount bracket right.....Qty 1

PARTS LISTING

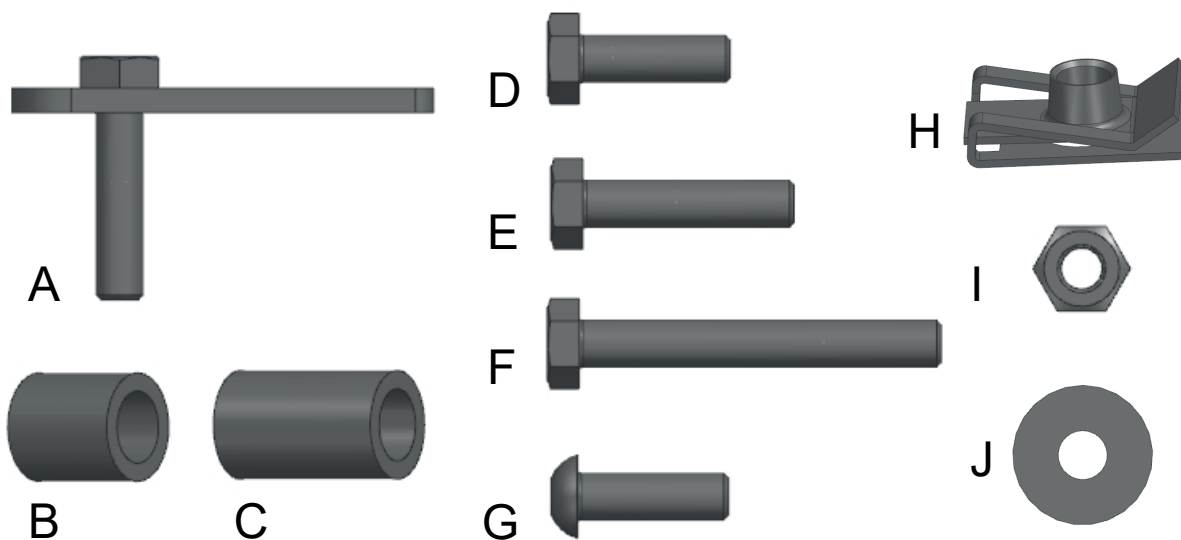

A. Insert bolt M8.....	Qty 2
B. Spacer 20 MM.....	Qty 2
C. Spacer 30 MM.....	Qty 2
D. Bolt M8x25.....	Qty 4
E. Bolt M8x35.....	Qty 2
F. Bolt M8x60.....	Qty 2
G. Screw M8x25.....	Qty 4
H. U-nut M8.....	Qty 6
I. Nut M8.....	Qty 2
J. Washer 8.....	Qty 16

INSTALLATION PROCEDURE



*If equipped, remove the factory skid plate or any other aftermarket skid plate.

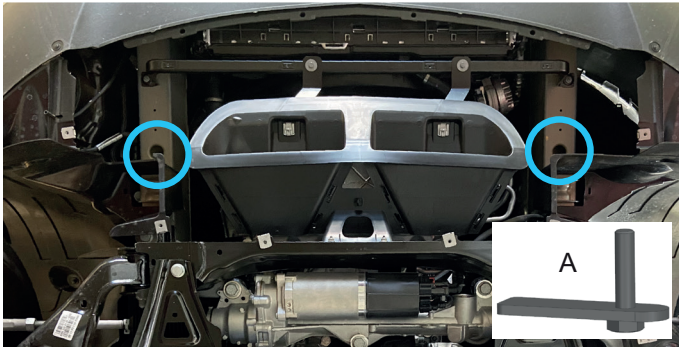

Fig. 1

1. Put insert bolts M8 (item A), as shown in fig.1.

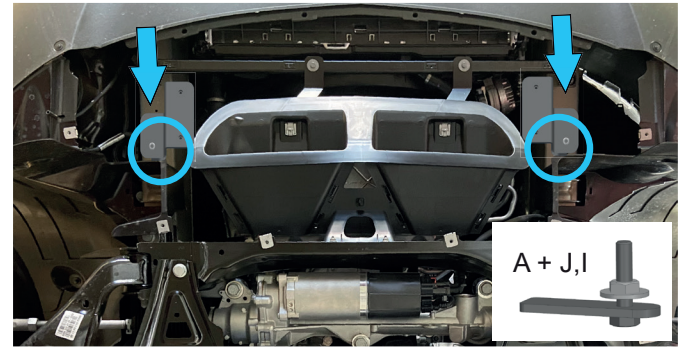

Fig. 2

2. Fix brackets (item 3,4) to the frame, using nuts M8 and washers M8 (item J,I), as shown in fig.2.

***Do not tighten yet.**

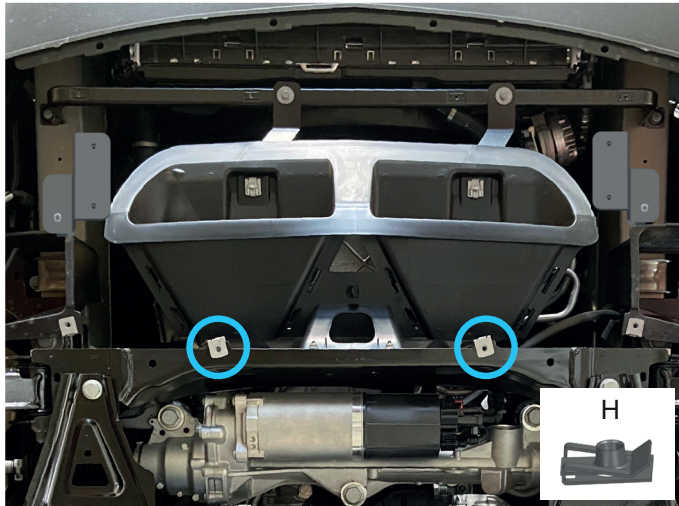

Fig. 3

3. Replace OEM cage nuts with U-nuts M8 (item H), as shown in fig.3.

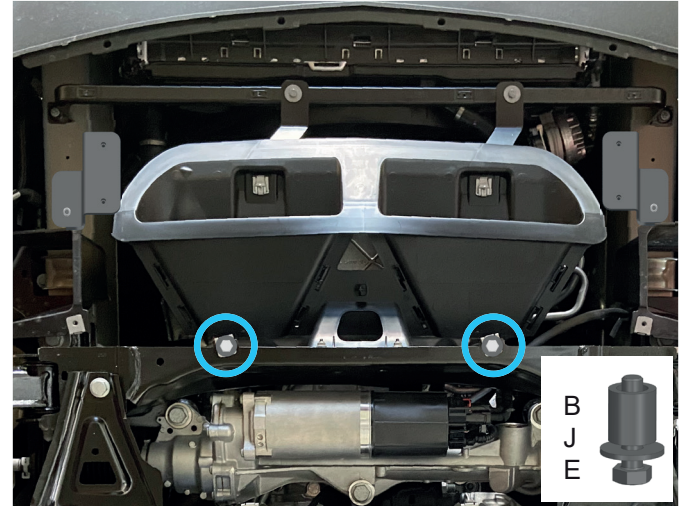

Fig. 4

4. Screw bolts M8x35 with washers 8 and spacers 20mm (item E, J, B) on 2-3 turns, as shown in fig.4.

***Do not tighten yet.**

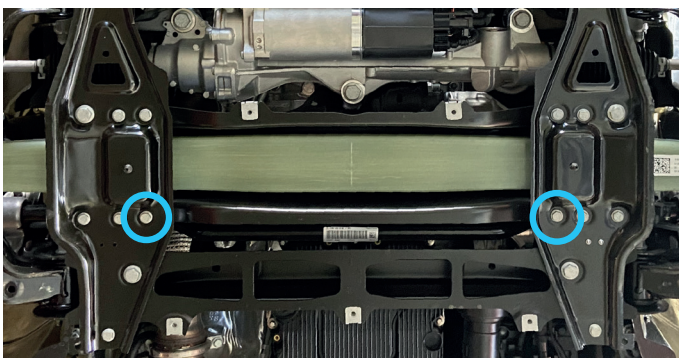

Fig. 5

5. Unscrew OEM bolts, as shown in fig.5.

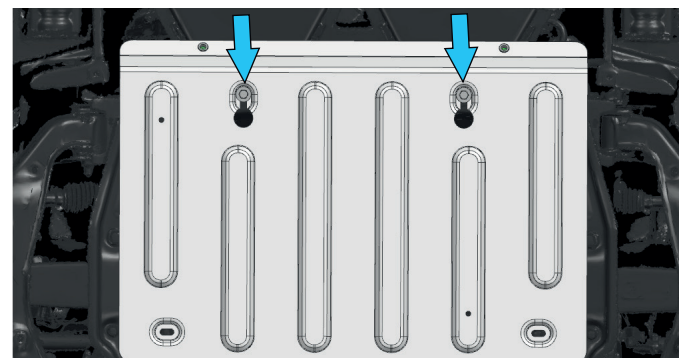

Fig. 6

6. Put the skid plate 2 (item 2) on pre-installed bolts M8x35 (item E), as shown in fig.6.

INSTALLATION PROCEDURE

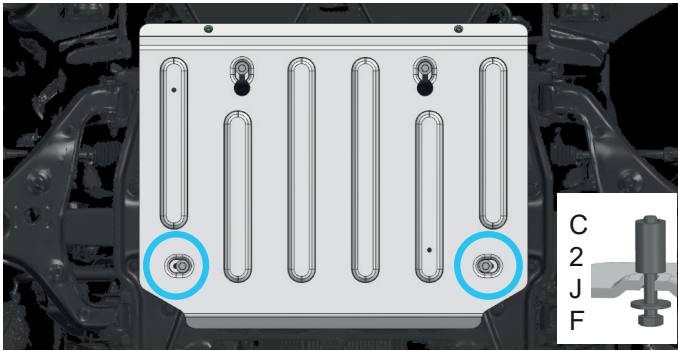

Fig. 7

7. Fix the back side of the skid plate 2 (item 2), using bolts M8x60, washers 8, spacers 30mm (item F, J, C), as shown in fig.7.

***Do not tighten yet.**

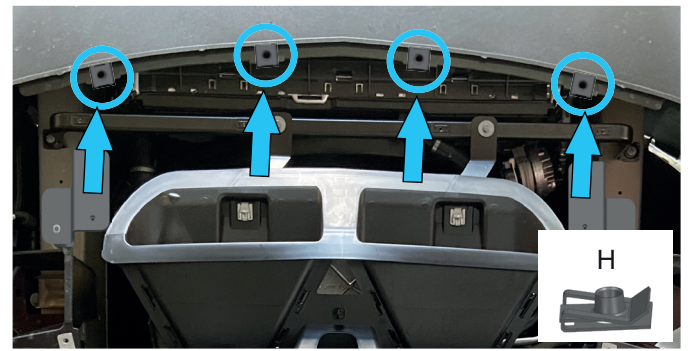

Fig. 8

8. Install the U-nuts M8 on the bumper (item H), as shown in fig.8.



Fig. 9

9. Screw bolts M8x25 and washers M8 (item D, J) on 2-3 turns, as shown in fig.9.

***Do not tighten yet.**

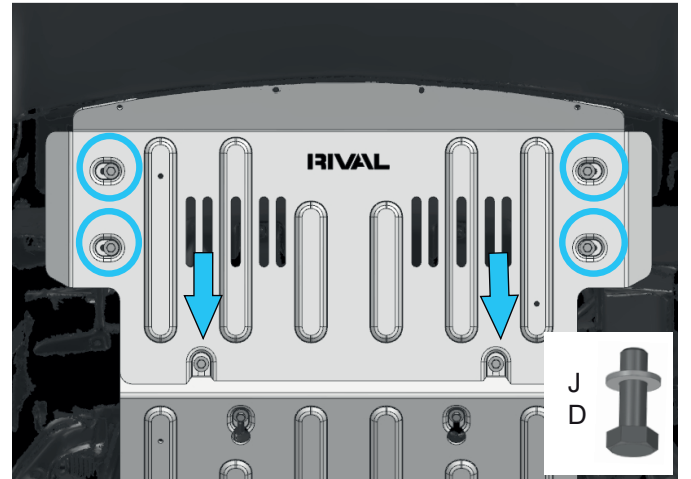

Fig. 10

10. Put the skid plate 1 (item 1) on pre-installed bolts (step 9), then fix it to the brackets (3,4), using bolts M8x25 and washers M8 (item D, J), as shown in fig.10.

***Do not tighten yet.**

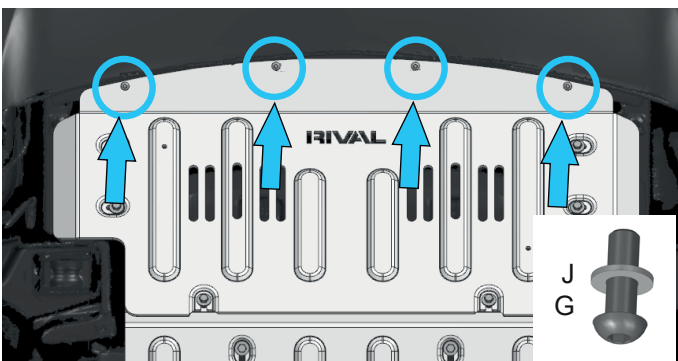

Fig. 11

11. Fix the skid plate 1 (item 1) to the OEM bumper, using bolts 8x25 and wahers M8 (item G, J), as shown in fig.11.

***Tighten hardware after that.**

Before operating a vehicle fitted with RIVAL Skid Plate:

- make sure all fittings are tightened;
- ensure the integrity of the structure and its components.

