

PRODUCT: TRANSFER CASE SKID PLATE

APPLICATION: INEOS GRENADIER (2023-PRESENT)

PART NO: 2333.4502.2.6



CAUTION!

To reduce the risk of serious injury or damage to property: Before you start installing and using this product, read the full instructions, pay special attention to the conditions of safe use and recommendations for installation! When installing or maintaining this product, it is necessary to use protective goggles. Check the integrity of the structure and the moment the fastening is tightened every 250 miles (400 kms) of mileage. Do not use this product if there is damage to the structure or fasteners!

NOTICE

Skid plate is an additional protection, but it can not guarantee to protect against all possible damage in collisions. When driving, be careful of objects and terrain that may damage sensitive parts of the vehicle.

TRANSFER CASE SKID PLATE

RIVAL

Part number: 2333.4502.2.6

Suited to vehicle: Ineos Grenadier 3.0, 3.0D AT 4WD (2023-Present)

Material: Aluminum, steel



SAFETY NOTICE

- * The RIVAL skid plate is designed to complement the use and design of the specified vehicle under conditions specified by the vehicle manufacturer.
- * While driving the vehicle at any speed, collision with any other vehicle, animal or object must always be avoided.
- * Following any collision with any other vehicle, animal or object, the RIVAL skid plate and the vehicle must be inspected by a specialized or suitably qualified vehicle repairer for possible damage to the components and assemblies in order to confirm suitability for further use of the vehicle.
- * It is strongly recommended that you do not operate a vehicle with a damaged skid plate or its components. In the case of damage, please contact the nearest RIVAL dealer. Vehicle, or where the skid plate has been damaged, is extremely dangerous and must be avoided at all cost.

INSTALLATION NOTICE

- * The RIVAL skid plate must be mounted and affixed to the vehicle according to this installation manual.
- * Personal safety during the installation process must be adhered to at all times.
- * Do not install this skid plate on vehicle models other than those allowed in this manual.
- * Estimated time for installation: 1 hour.

REQUIRED TOOLS

- * Basic tool kit
- * Torque wrench

TORQUE SETTING

- * M10 - 30 N·m (22.1 lb/ft)
- * M12 - 77 N·m (56.8 lb/ft)

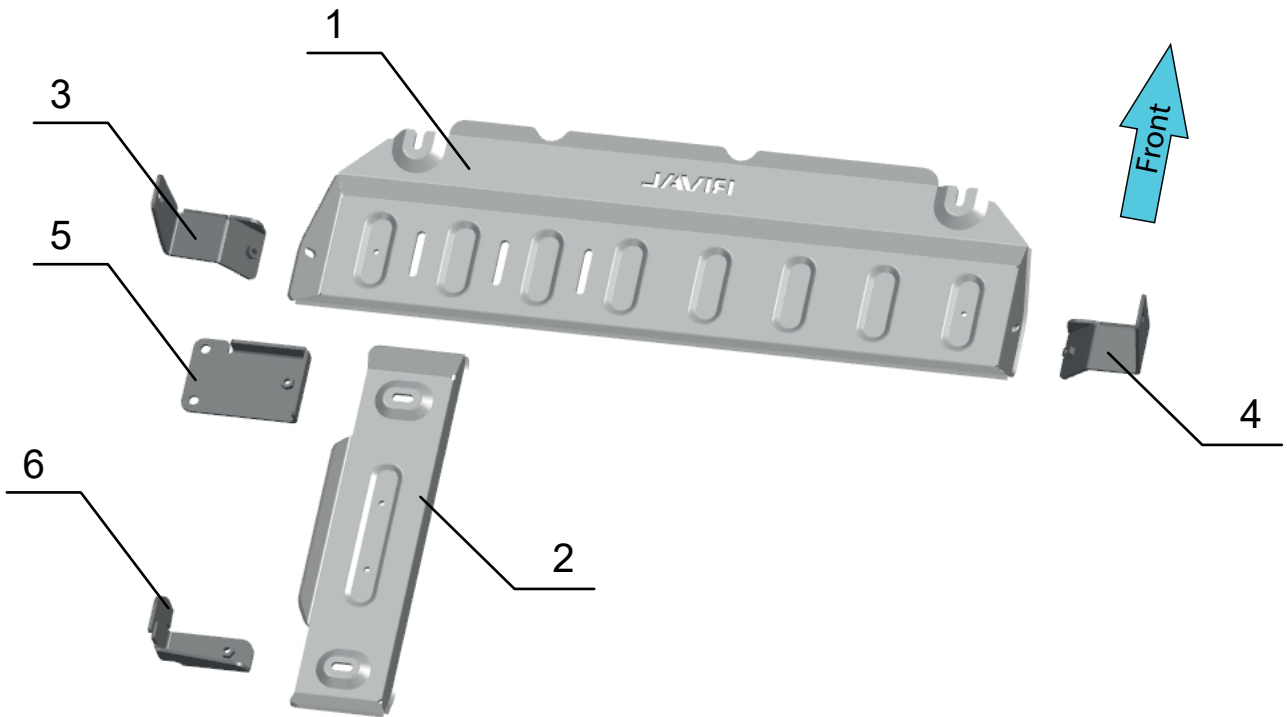

1. Transfer case skid plate.....	Qty 1
2. Fuel filter (diesel)/fuel pipes (gasoline) skid plate.....	Qty 1
3. Bracket left.....	Qty 1
4. Bracket right.....	Qty 1
5. Bracket 1.....	Qty 1
6. Bracket 2.....	Qty 1

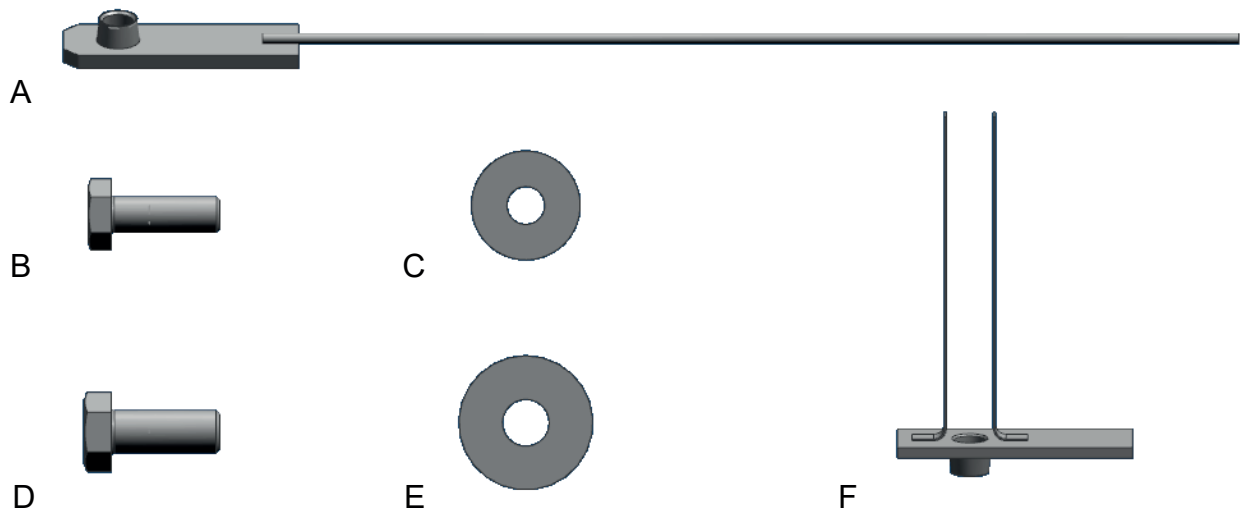

A. Insert nut M10 with wire.....	Qty 2
B. Bolt M10x30.....	Qty 9
C. Washer 10.....	Qty 9
D. Bolt M12x30.....	Qty 2
E. Washer 12.....	Qty 2
F. Insert nut M10 with wires.....	Qty 3

INSTALLATION PROCEDURE



*If equipped, remove the factory skid plate or any other aftermarket skid plate.

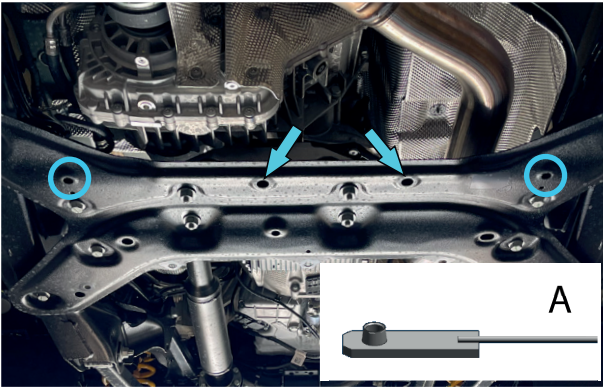

Fig. 1

1. Install insert nuts M10 with wire (item A) into side holes through center holes (fig.1).

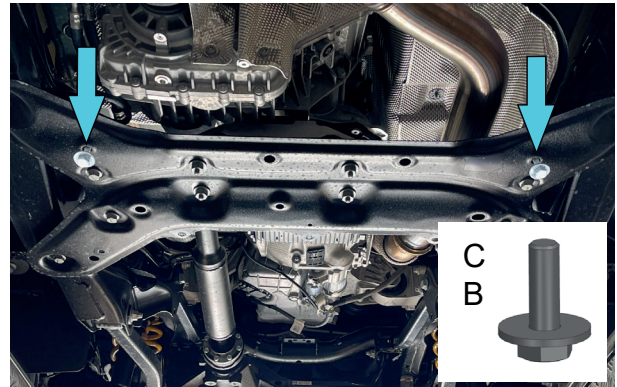

Fig. 2

2. Slightly screw bolts M10x30 with washers 10 (item B, C) into insert nuts M10 from step 1 (fig. 2).

***Do not tighten yet.**

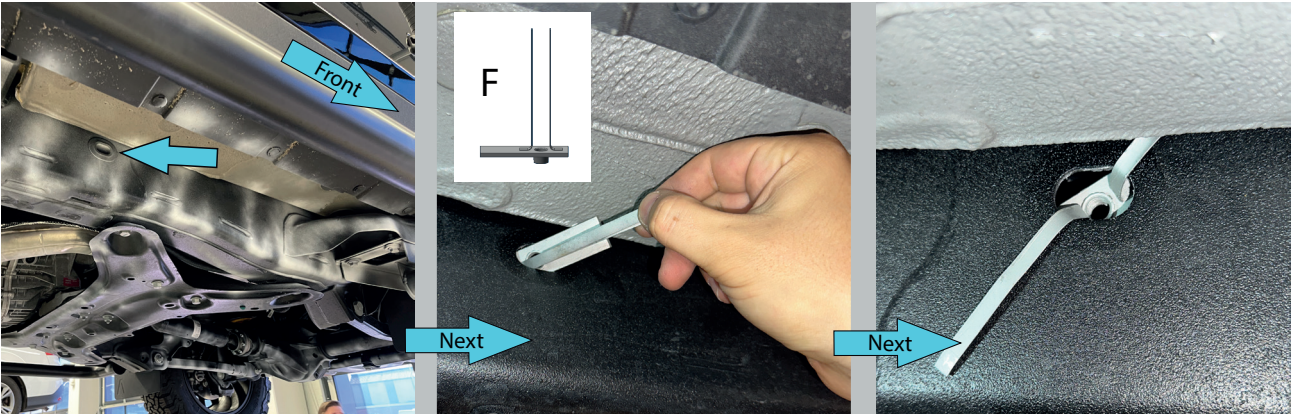

Fig. 3

3. Remove factory plug and install insert nuts M10 with wires (item F) into holes on both sides of the vehicle as shown in fig.3.

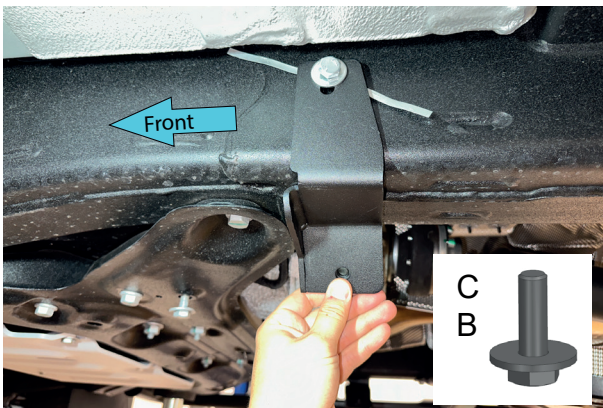

Fig. 4

4. Install left bracket (item 3) and fix it using bolt M10x30 with washer 10 (items B,C).

***Do not tighten yet.**

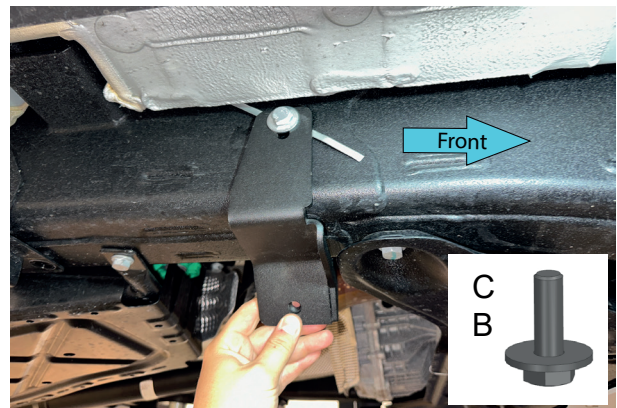

Fig. 5

5. Install right bracket (item 3) and fix it using bolt M10x30 with washer 10 (items B,C).

***Do not tighten yet.**



Fig. 6

6. Slide the transfer case skid plate (item 1) on pre-installed bolts M10x30 from step 2. Fix the skid plate to brackets using bolts M10x30 and washers 10 (items B, C) (Fig. 6).

***Tighten hardware after that.**

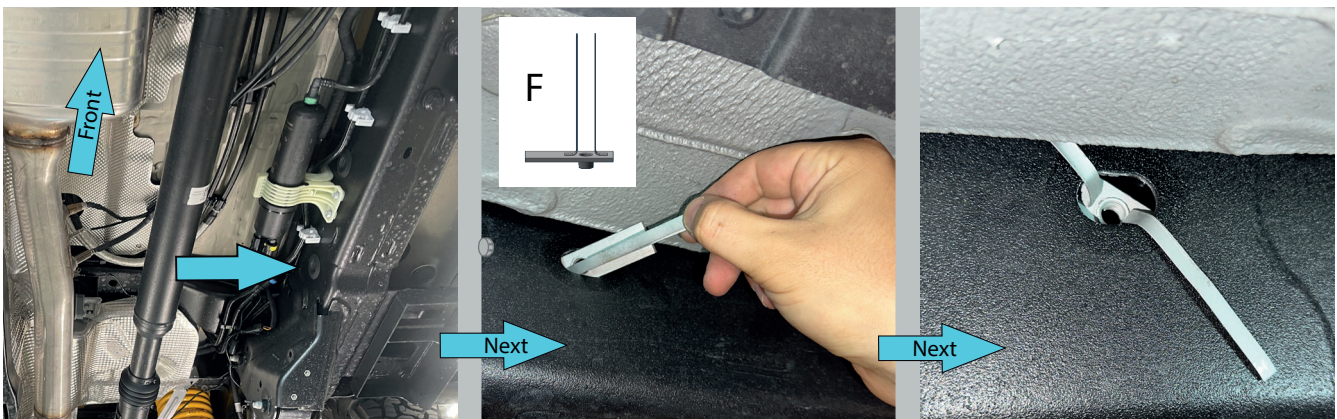

Fig. 7

7. Remove factory plug and install insert nut M10 with wires (item F) into hole as shown in fig.7.

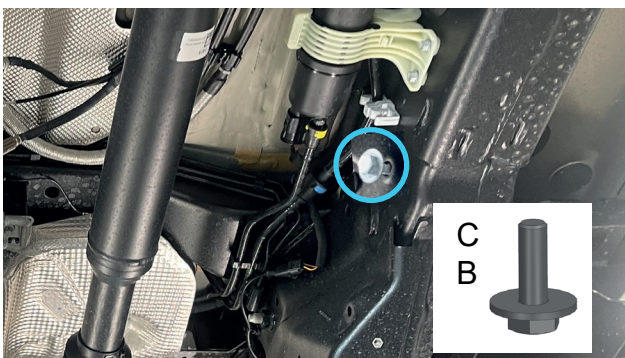

Fig. 8

8. Slightly screw bolt M10x30 with washer 10 (item B, C) into insert nut M10.

***Do not tighten yet.**



Fig. 9

9. Put bracket 2 (item 6) on pre-installed bolts M10x30 from step 8 (fig. 9).

***Do not tighten yet.**

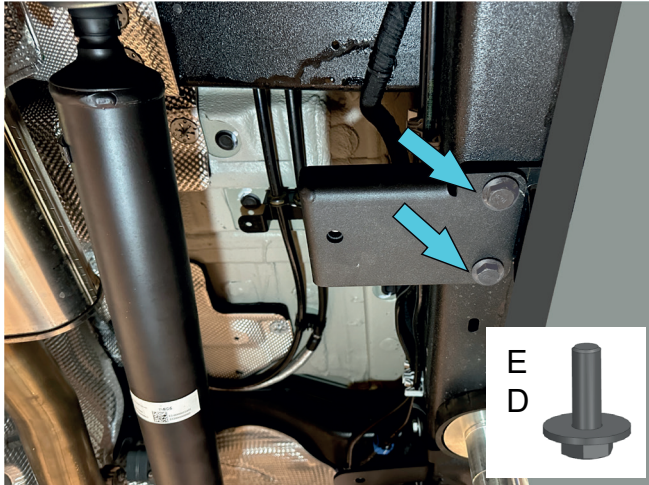

Fig. 10

10. If factory side steps are not pre-installed on vehicle, install and fix bracket 1 (item 5) using bolts M12x30 with washers 12 (items D,E).
***Do not tighten yet.**



Fig. 11

11. If factory side steps are pre-installed on vehicle, install bracket 1 (item 5) over factory side step brackets as shown in fig.11. Fix bracket 1(item 5) using factory fittings.
***Do not tighten yet.**

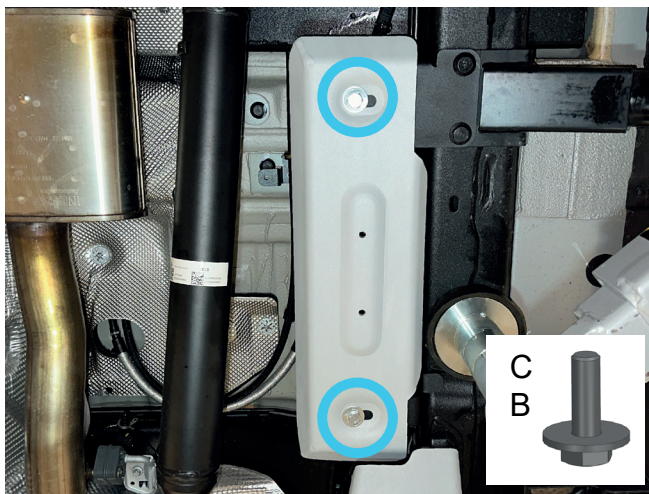

Fig. 12

12. Install the fuel filter (diesel)/fuel pipes (gasoline) skid plate (item 2) on pre-installed brackets. Fix the skid plate using bolts M10x30 and washers 10 (item B, C) (Fig. 12).
***Tighten hardware after that.**

Before operating a vehicle fitted with RIVAL Skid Plate:

- make sure all fittings are tightened;
- ensure the integrity of the structure and its components.

