

EN ENGINE BAY PROTECTION INSTALLATION MANUAL

DE MONTAGEANLEITUNG FÜR MOTORSCHUTZ



**Underbody Armour for:
Toyota Land Cruiser 300 (2021-)**

2333.9559.1.6

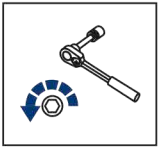

EN Regular fasteners
DE Originale montageile

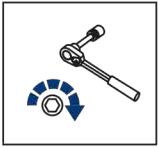

EN Regular fasteners
DE Originale montageile



EN Screw a several turns
DE Für wenigen Umdrehungen befestigen



EN Loosen bolts
DE Bolzen lockern

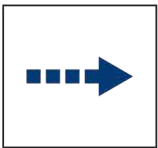

EN Movement Arrow
DE Bewegungsrichtung

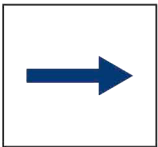





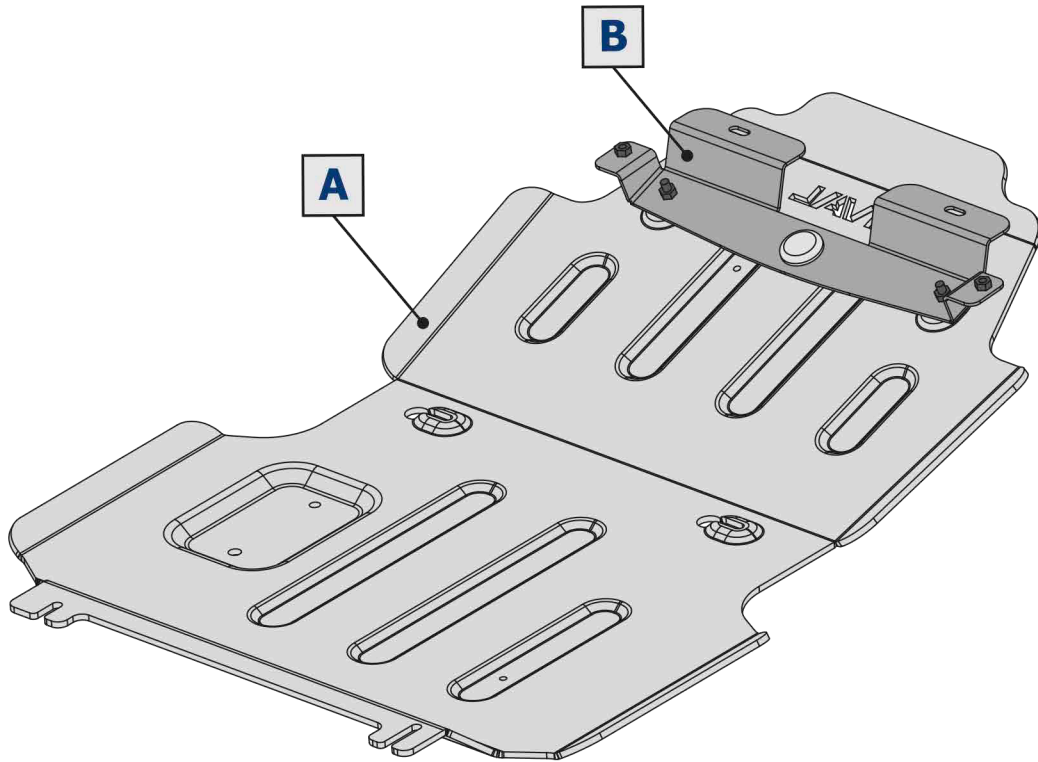

EN Location/Position Arrow
DE Anordnung/Positionsrichtung

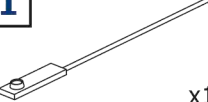

EN Screw Arrow
DE Drehungsrichtung



1  x1	2  x2	3  M8x20 x4	4  M8x30 x2	5  M8x40 x2	6  Ø8 x10
--	---	---	---	---	---

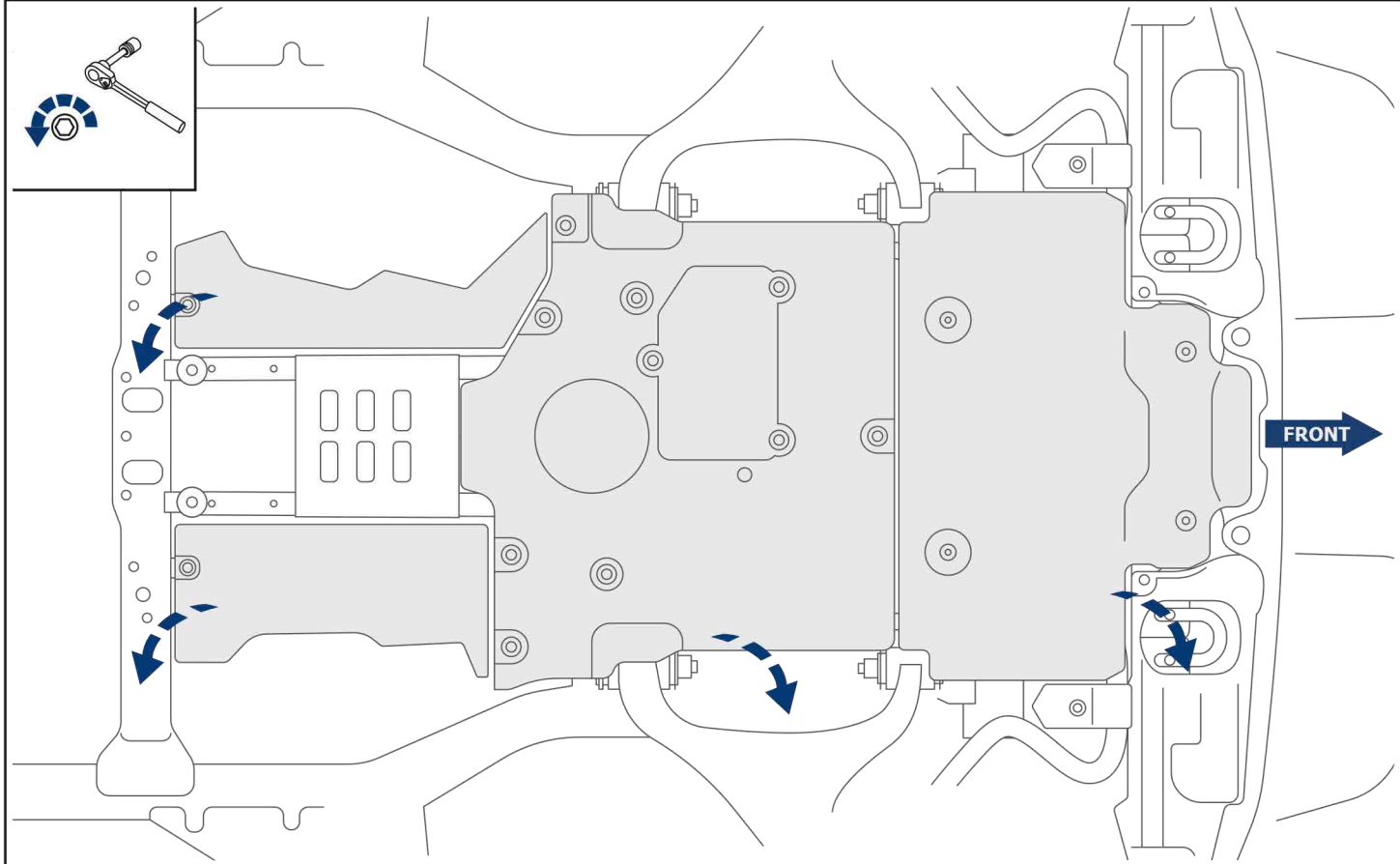
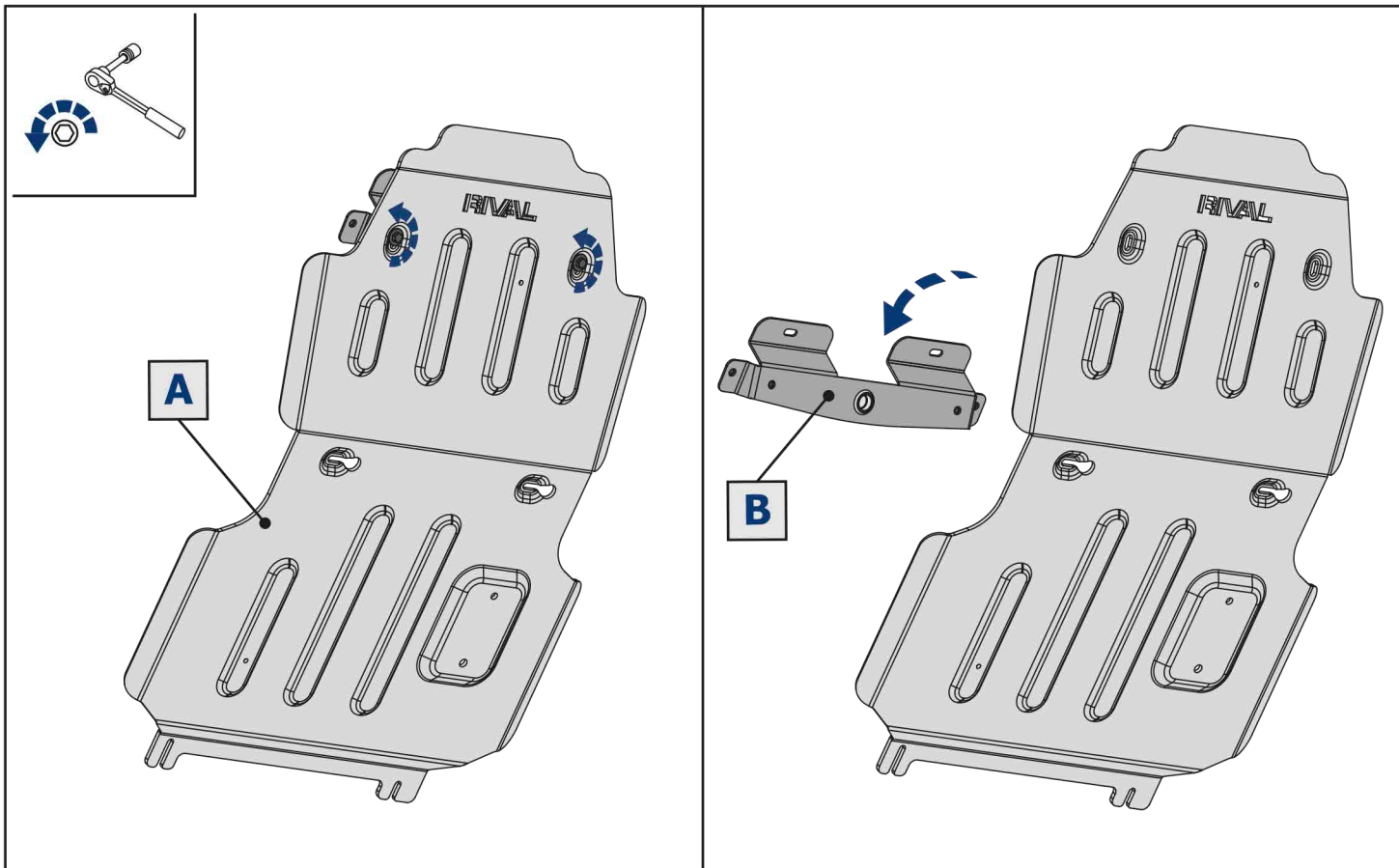

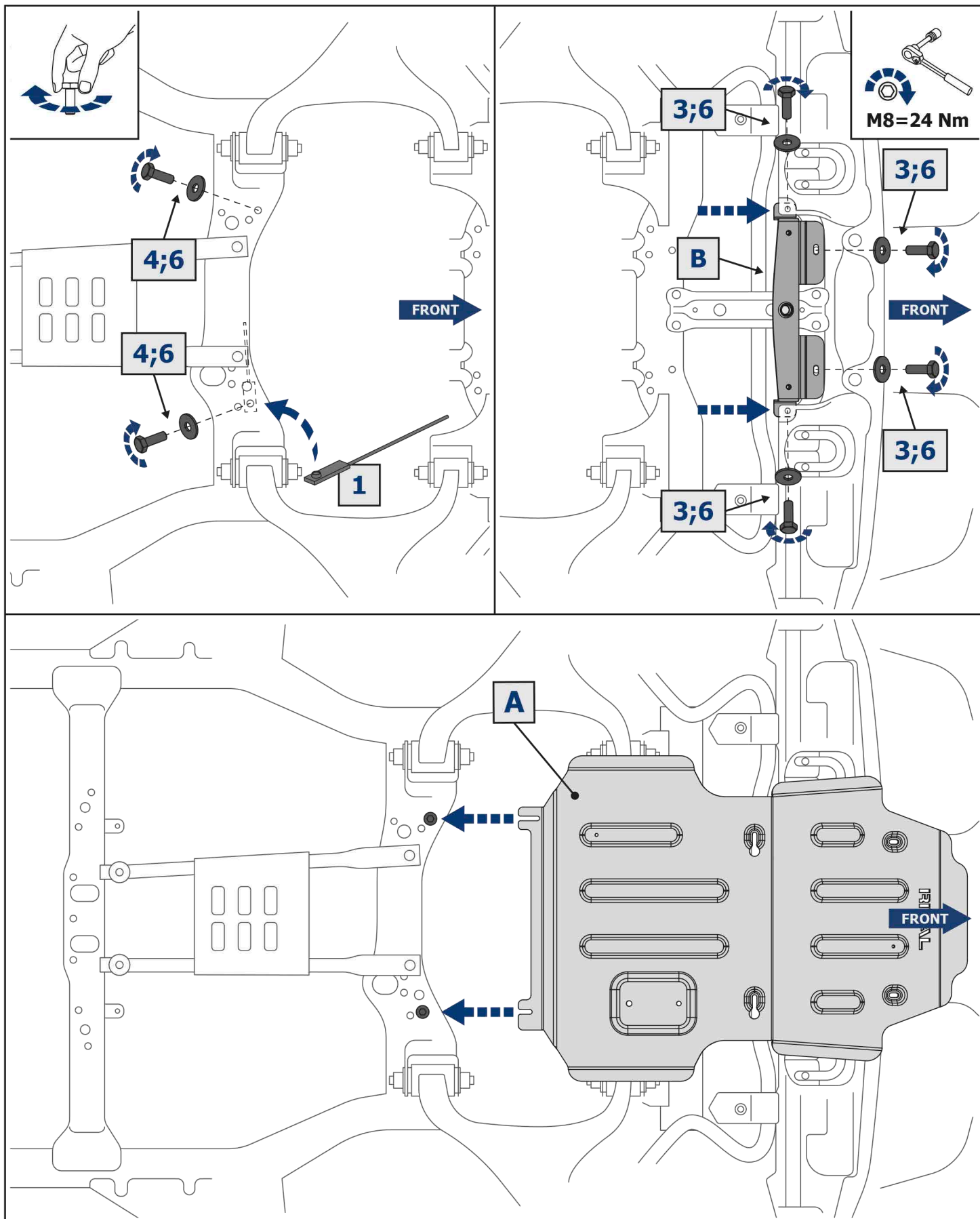

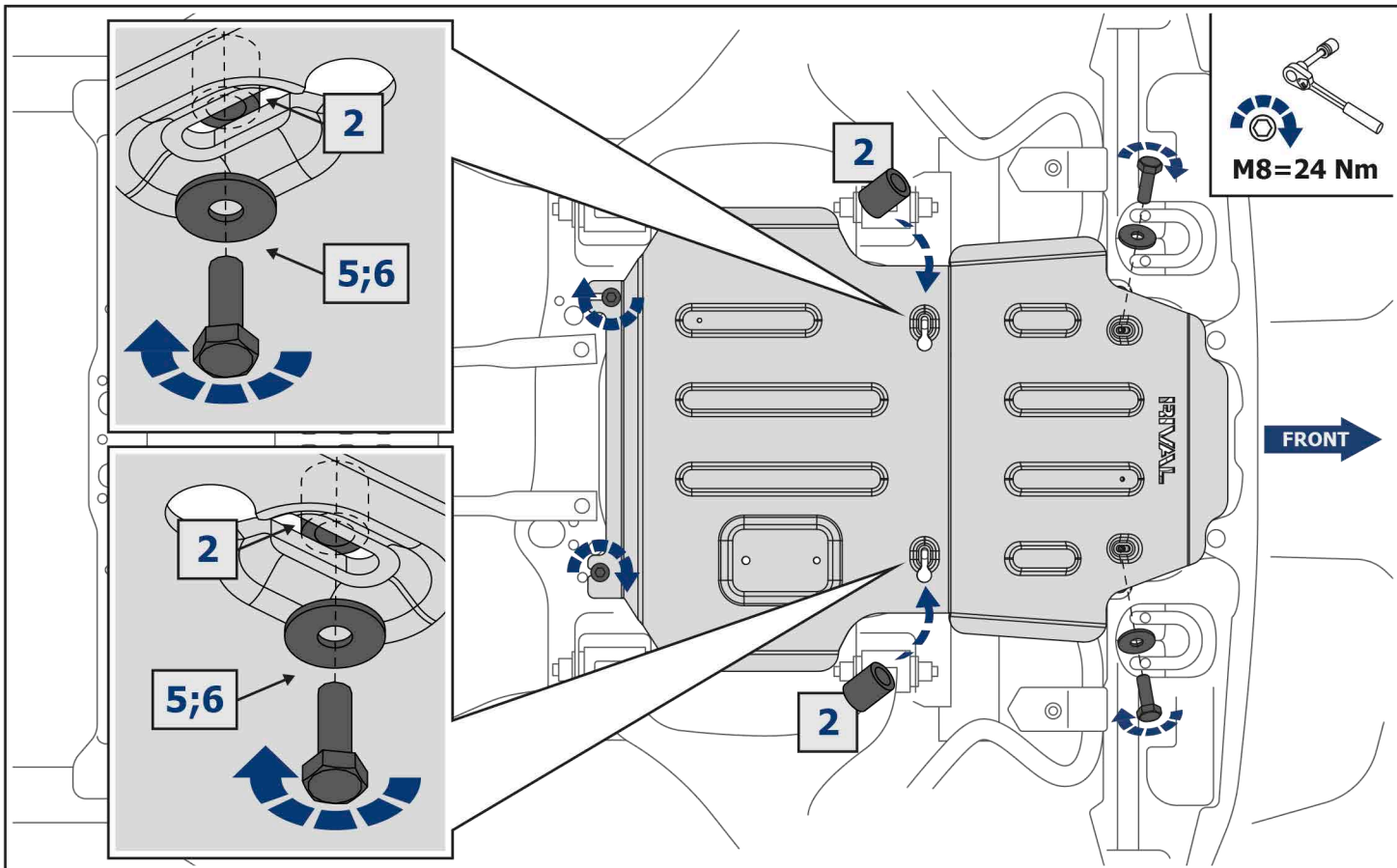

(EN) Mounting requirements:

Underbody Armour is developed individual for each car model.

Underbody Armour must be mounted according to installation manual by an authorized car dealer or by a special car repair stations.

Underbody Armour is to be installed to original points and holes of the power units of the car.

Installed properly Underbody Armour doesn't scrape another parts and assembly of the car.

(DE) Montageanleitung:

Der Unterfahr-/Unterbodenschutz wurde für jedes Fahrzeug individuell entwickelt. Der Unterfahr-/Unterbodenschutz ist gemäß Installationsanleitung des Herstellers bei einer autorisierten Werkstatt oder Autohändler zu montieren. Der Unterbodenschutz wird an den originalen Befestigungsbohrungen der Karosserie montiert. Bei Montage gemäß Herstellervorgaben werden keine anderen Karosserieteile beschädigt oder in Mitleidenschaft gezogen.

(EN) Working requirements:

Underbody Armour is designed for use and drive of the vehicle in conditions considere by the car manufacture.

While driving the carat speed, cases of collisions with large obstacles and objects need to be excluded.

In the case of a collision with an obstacle Underbody Armour and the vehicle must be inspected in a specialized car repair stations for damage of the components and assemblies and suitability for further use.

(DE) Herstellervorgaben:

Der Unterfahr-/Unterbodenschutz ist gemäß den Vorgaben des Fahrzeugherstellers zu verwenden. Das Befahren und Zusammenstoßen von/mit Hindernissen und großen Objekten ist zu unterlassen. Nach erfolgtem Zusammenstoß muss die Funktionsfähigkeit des Fahrzeuges und/oder entstandene Mängel von einer autorisierten Werkstatt überprüft werden.

(EN) Warranty:

Warranty period - 12 months.

(DE) Gewähr:

Die Dauer der Gewährleistung beträgt 12 Monate.

(EN) Warranty terms and conditions:

Underbody Armour is installed on the car, with good condition of the body and the assembly parts (the car, that was not involved in the accident).

Absence of mechanical damages of the Underbody Armour caused by a head-on crush;

Compliance with all installation requirements;

Absence of powder coating damages of the Underbody Armour;

The manufacturer is not liable for any damage caused to the vehicle, the life and health of people in the event of breach of the installation and using of Underbody Armour. The manufacturer has the right to change the design of Underbody Armour.

(DE) Gewährleistung:

Der Unterfahr-/Unterbodenschutz muss ohne Beschädigung und/oder Änderungen an Karosserie montiert worden sein. Es dürfen keine Schäden durch die Kollision mit Hindernissen/Gegenständen entstanden sein. Die Vorgaben der Montageanleitung müssen exakt eingehalten werden. Es dürfen keine Schäden/Kratzspuren an der Pulverbeschichtung vorhanden sein. Der Hersteller übernimmt keine Haftung für Fahrzeugschäden jedweder Art und gesundheitliche Gefährdungen durch fehlerhafte Montage und Nutzung des Unterbodenschutzes. Der Hersteller behält sich vor, Design und Konstruktionsänderungen des Unterbodenschutzes zu ändern.

All products are certified
Alle Produkte sind zertifiziert

