

INSTALLATION MANUAL

PRODUCT: REAR BUMPER

MODEL: FORD RANGER (2022 - PRESENT)

PART NO: 2D.1816.1-NL



CAUTION!

To reduce the risk of serious injury or damage, please read and understand all instructions and procedures before attempting to install or use this product. Safety glasses must be worn at all times during installation or maintenance of this product. Ensure all mounting bolts are tensioned after 400 km (250 miles) and periodically thereafter.

NOTICE

Whilst the bumper adds additional protection to your vehicle, precautionary measures still need to be taken to avoid damage. Always drive to the conditions and your surroundings.

REAR BUMPER



Part number 2D.1816.1-NL

Suited to vehicle: FORD RANGER DOUBLE CAB (2022 - PRESENT)

Material: Aluminum / Steel



SAFETY NOTICE

- * The Bumper is designed to compliment the use and design of the specified vehicle under conditions specified by the vehicle manufacturer.
- * While driving the vehicle at any speed, collision with any other vehicle, animal or object must always be avoided.
- * Following any collision with any other vehicle, animal or object, Bumper and the vehicle must be inspected by a specialized or suitably qualified vehicle repairer for possible damage to the components and assemblies in order to confirm suitability for further use of the vehicle.
- * It is strongly recommended that you do not operate a vehicle with a damaged bumper or its components. In the case of damage, please contact the nearest Rival authorised stocklist.
- * The operation of a vehicle where the bumper is not properly attached and fastened to the vehicle, or where the bumper has been damaged, is extremely dangerous and must be avoided at all cost.
- * It is recommended that you carry out regular inspections of all the bumper elements such as all bolts, wires, connectors.

INSTALLATION NOTICE

- * The Bumper must be mounted and affixed to the vehicle according to the installation manual provided by an authorized Rival dealer or Motor dealer or by a special vehicle repairer or fitment center.
- * Estimated time for installation: 2 hours.
- * Personal safety during the installation process must be adhered to at all times and the use of personal safety equipment is highly recommended.
- * Do not install this bumper on vehicle models other than those allowed in this manual.
- * Check state and local highway safety laws regarding permitted bumper types and heights.

REQUIRED TOOLS

- * Basic tool kit
- * Torque wrench
- * Crosspoint and flat head screwdriver

TORQUE SETTING

- * M6 - 9 Nm,
- * M10 - 30 Nm,
- * M12 - 77 Nm

*RECOVERY POINTS



WARNING

Do not exceed the Working Load Limit of these recovery points or shackle.

INSPECTION AND SAFETY

Recovery of stuck vehicles can be dangerous. Always inspect the shackle and recovery points before each use. Do not use if there are visible signs of damage or wear including cracking (or elongation). Always stay a safe distance away from the recovery area - at least 1.5 times the length of the recovery strap. Incorrect use of receivers equipment can result in serious injury or death.

Always use recovery points as a matched pair teamed with an equalising bridle during any recovery situation.

Please attach this "Warning" label to the door aperture.

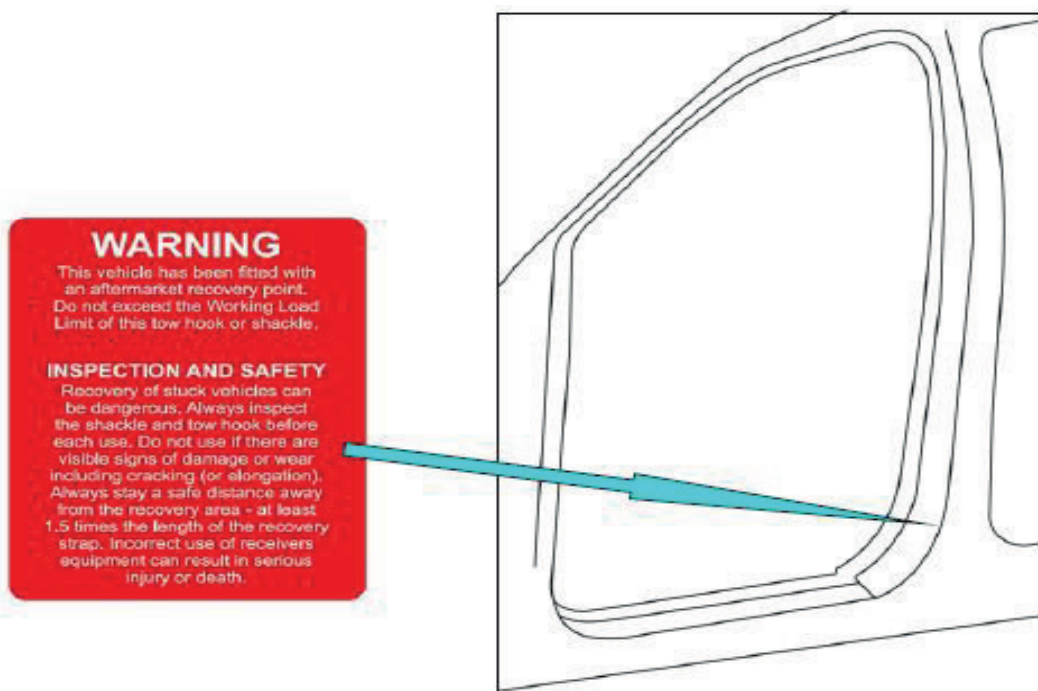

*TOW BAR INSTALLATION

The bumper design provides for installation of the American-style tow bar – square 2 (50.8 mm).

Maximum allowable vertical static load on the tow bar should be not more than 350 kg.

Maximum towing capacity:

Unbraked towing capacity, kg:	Braked towing capacity kg:
750	3500

Caution!

Towing of the trailer which is in compliance with specified requirements may result in damage to tow bar or bumper.

*LIGHTS

The bumper provides for the light mounting points.

Overall dimensions of the lights under installation:

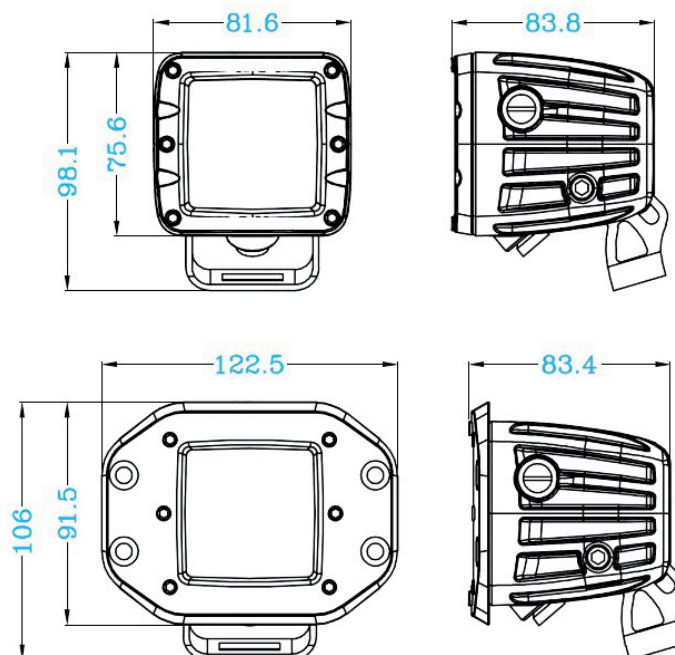

PARTS LISTING

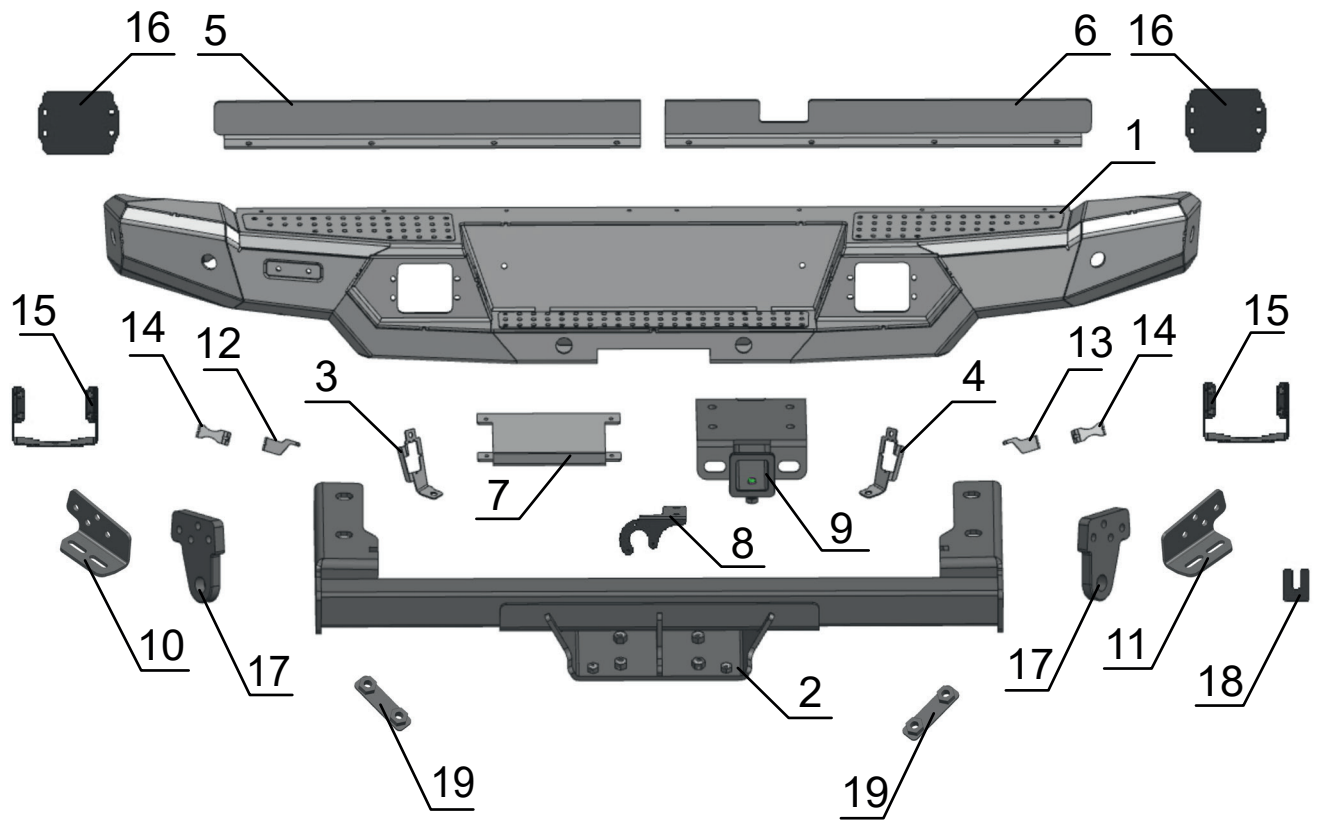

- | | | | |
|---|-------|--|--------|
| 1. Aluminum bumper body..... | Qty 1 | 11. Bumper body bracket right..... | Qty 1 |
| 2. Bracket | Qty 1 | 12. Parking sensor holding bracket left... | Qty 1 |
| 3. Left bracket for license plate light..... | Qty 1 | 13. Parking sensor holding bracket right. | Qty 1 |
| 4. Right bracket for license plate light..... | Qty 1 | 14. Parking sensor holding bracket..... | Qty 4 |
| 5. Backing of bumper body left..... | Qty 1 | 15. LED bracket..... | Qty 2 |
| 6. Backing of bumper body right..... | Qty 1 | 16. Lamp plug..... | Qty 2 |
| 7. Bottom plug..... | Qty 1 | 17. Recovery points..... | Qty 2 |
| 8. Tow bar socket bracket..... | Qty 1 | 18. Adjusting plate 2mm..... | Qty 12 |
| 9. Tow bar square..... | Qty 1 | 19. Insert nut..... | Qty 2 |
| 10. Bumper body bracket left..... | Qty 1 | | |

PARTS LISTING

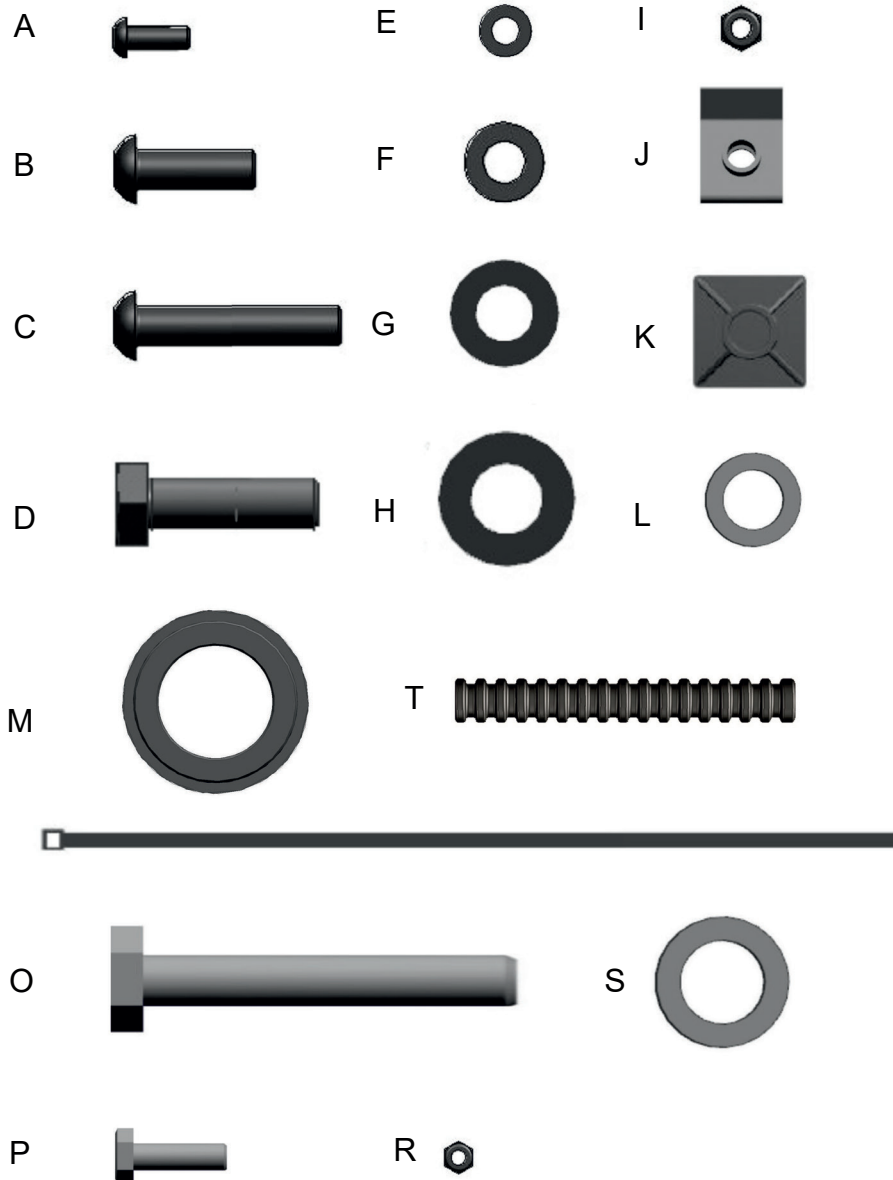

A. Screw M6x20.....	Qty 34
B. Screw M10x30.....	Qty 4
C. Screw M10x50.....	Qty 2
D. Bolt M12x1.25x40.....	Qty 4
E. Washer 6.....	Qty 42
F. Washer 10.....	Qty 6
G. Washer 12 (2 pc. preinstalled, as travel hardware, in bumper bracket (item. 2)).....	Qty 6
H. Washer penny 12.....	Qty 4
I. Nut M6.....	Qty 8
J. U-nut M6.....	Qty 16
K. Cable clip.....	Qty 10
L. Spacer.....	Qty 2
M. Parking sensor washer.....	Qty 6
N. Cable tie.....	Qty 10
O. Bolt M12x1.25x70 (2 pc. preinstalled, as travel hardware, in bumper bracket (item. 2)).....	Qty 6
P. Bolt M6x16.....	Qty 8
R. Nut M5.....	Qty 3
S. Spring washer 12.....	Qty 4
T. Corrugated pipe (0.3m).....	Qty 1

INSTALLATION PROCEDURE



Before installation: Unscrew bolts M10x30 and washers 10, preinstalled as travel hardware, in bumper bracket (item 2) and aluminum bumper body (item 1).

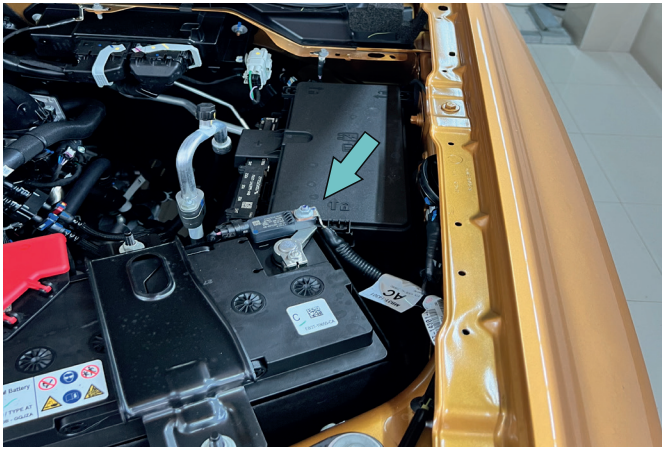

Fig. 1

1. Open the hood. Disconnect terminal “-” from the vehicle battery (Fig. 1).

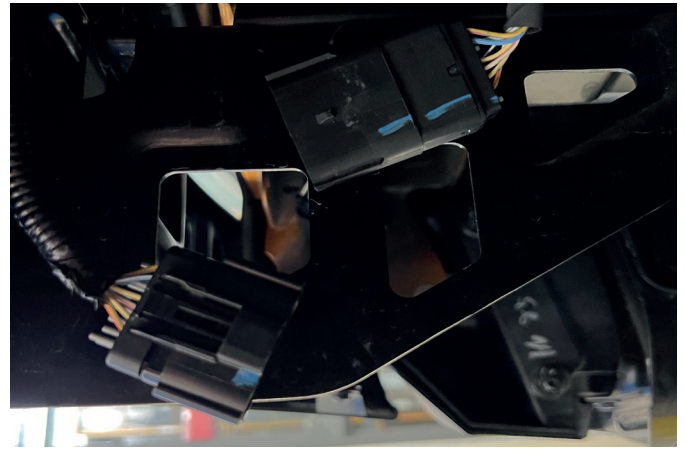

Fig. 2

2. Disconnect OE bumper connector, as shown in fig. 2.

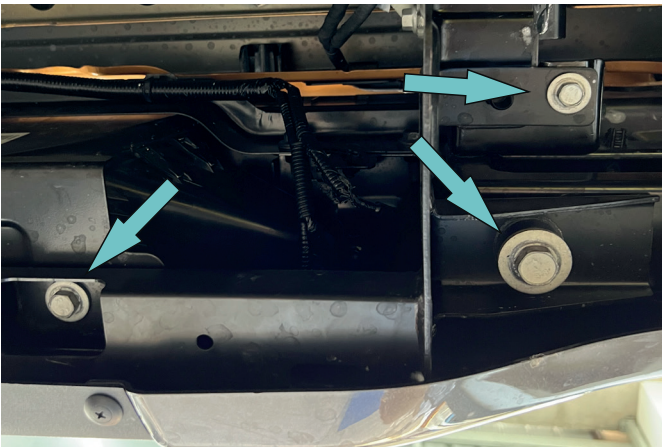

Fig. 3

3. Unscrew OE bumper fixation bolts, from OE bracket on both sides of the vehicle.



Fig. 4

4. Remove OE bumper, as shown in fig.4.

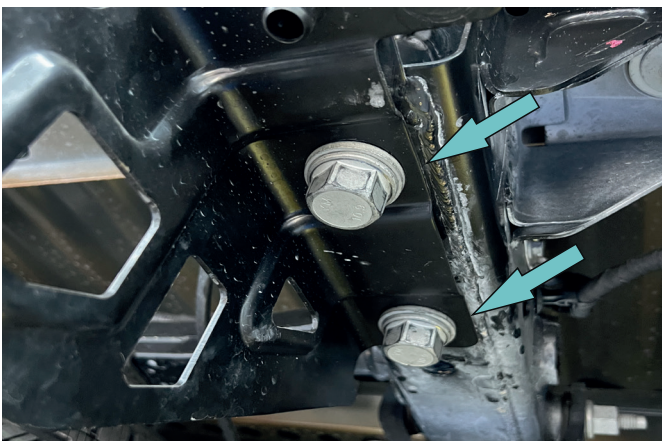

Fig. 5

5. Unscrew OE bumper bracket fixation bolts on both sides of the vehicles (Fig. 5).

Set aside to reuse later on.



Fig. 6

6. Disconnect parking sensors plugs (fig.6).

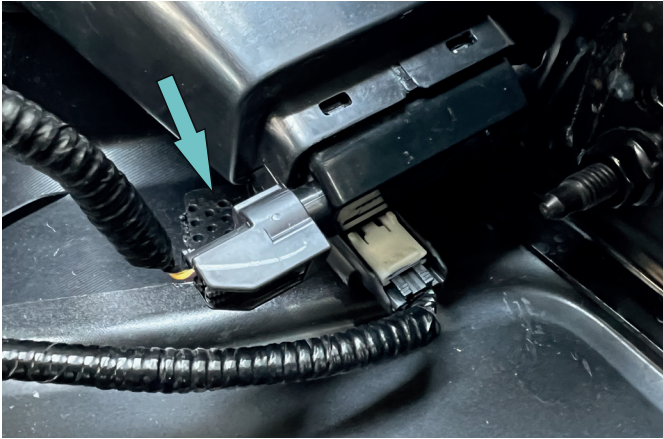

Fig. 7

7. Disconnect license plate lights connectors (Fig. 7).

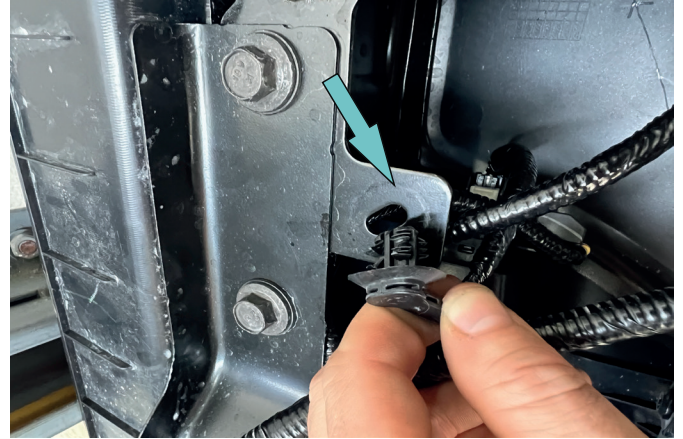

Fig. 8

8. Disconnect parking sensors wiring from plastic bumper reinforcement (Fig. 8).



Fig. 9

9. Remove wiring from OE bumper (Fig. 9).



Fig. 10

10. Remove all parking sensors (Fig. 10).



Fig. 11

11. Remove the license plate lights from OE bumper (Fig. 11).



Fig. 12

12. Remove LED lights from plastic box (Fig. 12).

INSTALLATION PROCEDURE

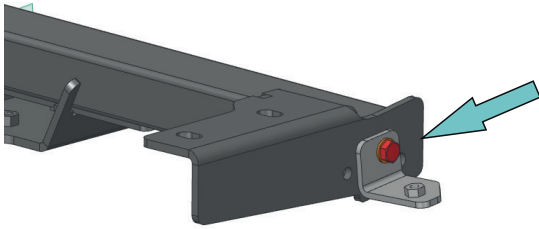

Fig. 13

13. Remove transport brackets before starting the installation. Unscrew bolts M12x1.25x70 and washers 12, preinstalled as travel hardware, in bumper bracket (item 2) (Fig. 13) **Set aside to reuse later on.**

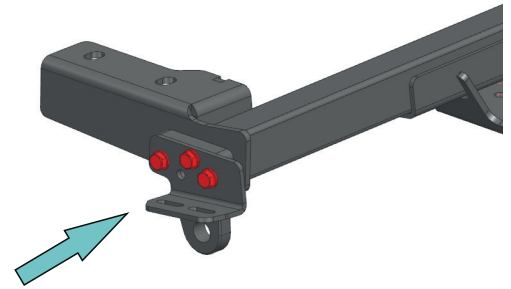

Fig. 14

14. Fix towing hooks (item 17), bumper body bracket left (item 10) and bumper body bracket right (item 11) using bolts M12x1.25x70 and washers 12 (item O,G) (Fig. 14). ***Tighten hardware after that.**

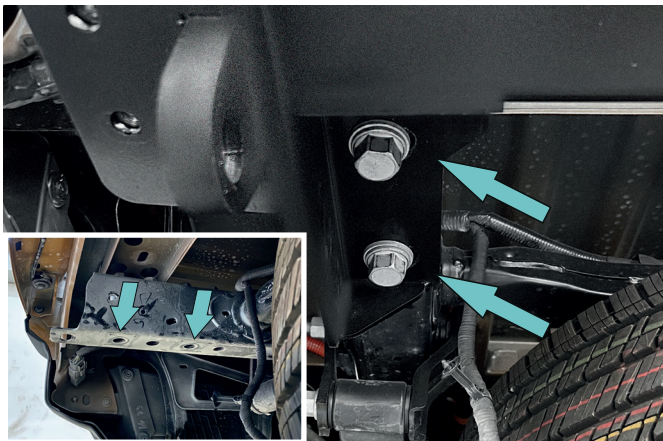

Fig. 15

15. Install bracket (item 2) on the vehicle, using OE bolts M14 as shown in fig.15. ***Do not tighten yet.**



Fig. 16

16. Align bracket on the vehicle regarding to the frame of the vehicle. ***Tighten hardware after that.**

Steps 17-22 (if there are parking sensors).

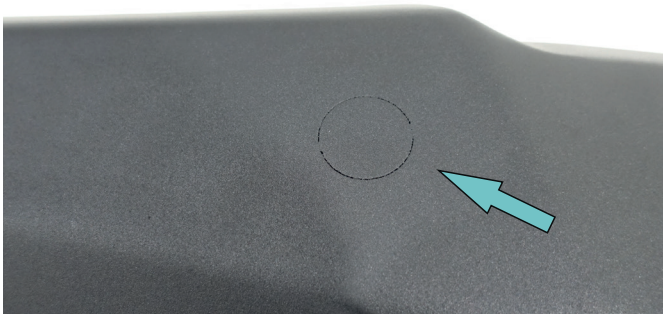

Fig. 17

17. Locate knock-outs for parking sensors on the bumper body (item 1) and knock them out by a hammer (Fig.17).



Fig. 18

18. Install parking sensor washers (pos. M) (Fig.18).

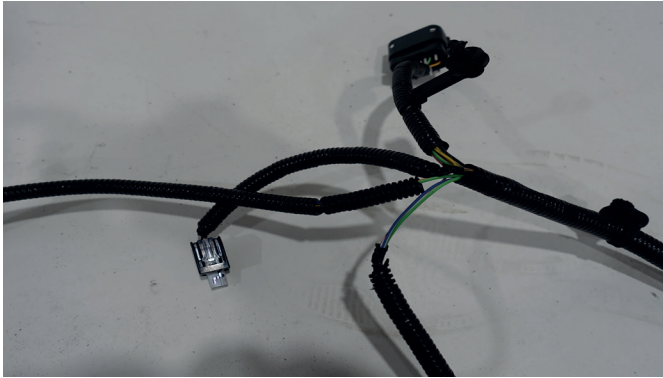

Fig. 19

19. Strip the insulation in the area of the central parking sensors in the stock wiring harness (step 9). Pull the wires for the central parking sensors out of the main harness (make sure there is plenty of slack in the wiring).

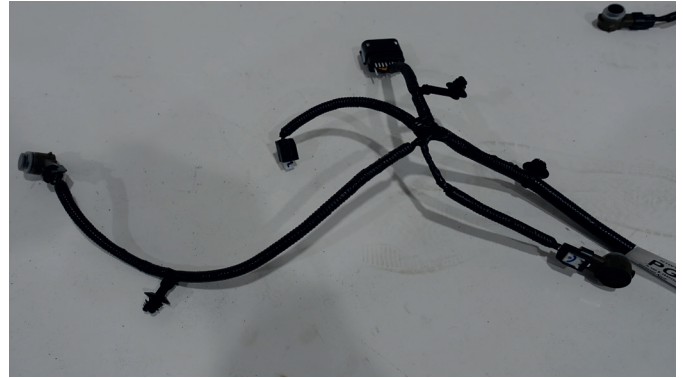

Fig. 20

20. Slide a piece of corrugated tube (item T) over the exposed wires and insulate the wiring harness. Repeat steps 19-20 on the other side.



Fig. 19

21. Put OE parking sensor into central part of the bumper body and fix them, using parking sensors holding brackets (item.12,13), bolts M6 and washers 6 (item P, E) (Fig.19).



Fig. 20

22. Put OE parking sensor into side parts of the bumper body and fix them, using parking sensors holding brackets (item.14), bolts M6 and washers 6 (item P, E) (Fig.20).

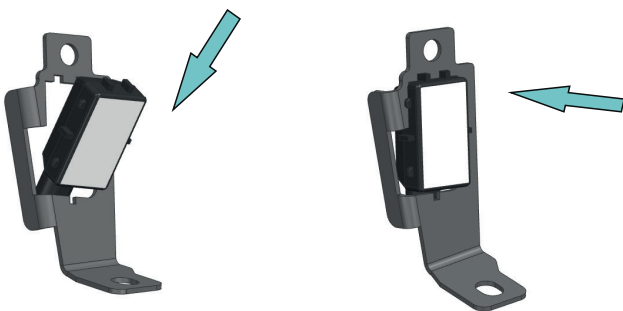

Fig. 21

23. Install OE LED lights into brackets for license plate light (item 3,4) (Fig.21).

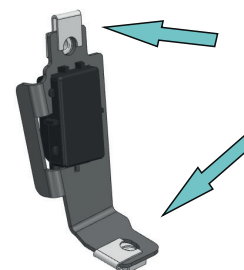

Fig. 22

24. Install U-nuts M6 (item J) on brackets for license plate light (item 3,4). (Fig.22).

INSTALLATION PROCEDURE

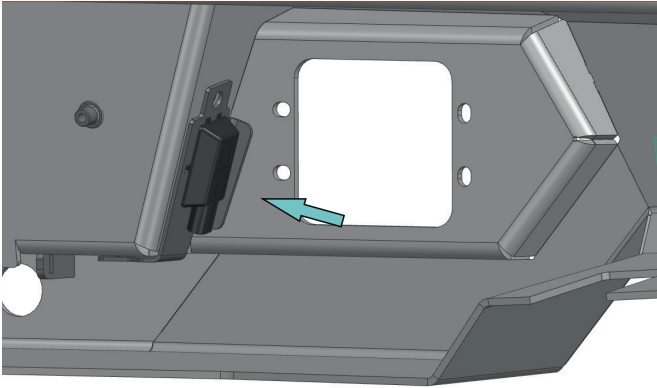

Fig. 23

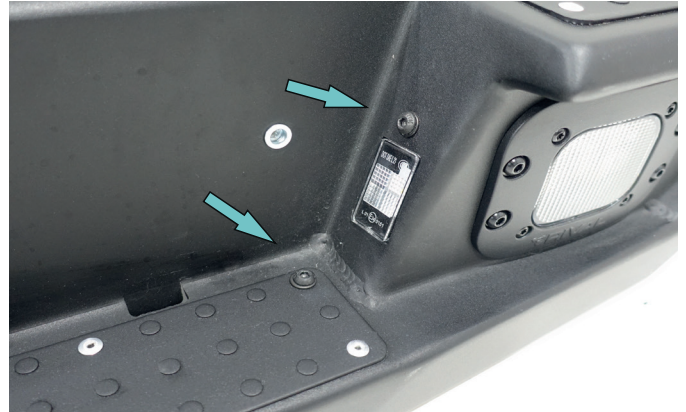

Fig. 24

25. Install brackets for license plate lights (item 3,4) with LED lights into the bumper body (item 1) using screws M6 and washers 6 (item A, E) (Fig.23,24).

***Tighten hardware after that.**



Fig. 25

26. Fix your aftermarket LED cubic lights to brackets (item 15). This brackets are not compatible with flush mount LED lights (parts number 2D.0042.1, purchased separately).

***Tighten hardware after that.**

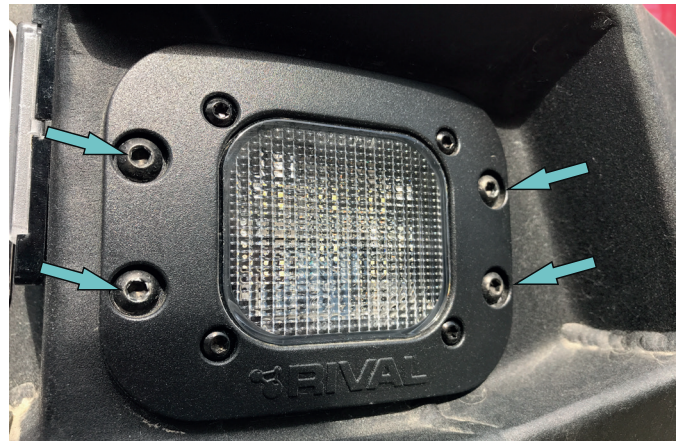

Fig. 26

27. Install LED lights or Lamp plug (item 16), using screws M6, washers 6 and nuts M6 (item A, E, I) (Fig.26).

***Tighten hardware after that.**

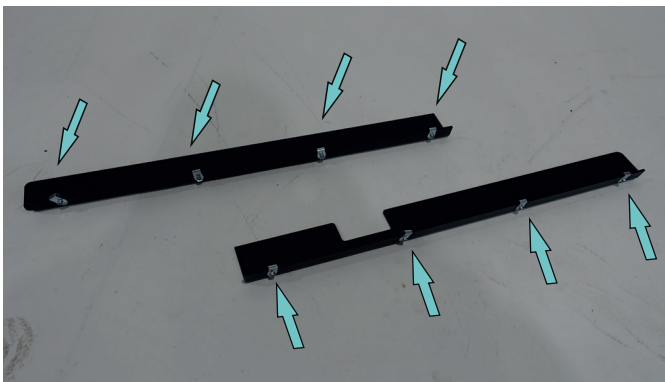

Fig. 27

28. Install U-nuts M6 (item J) into inside part of backings of bumper body (item 5,6). (Fig.27).



Fig. 28

29. Install backings of bumper body (item 5,6) onto bumper body (item 1) using screws M6 and washers 6 (item A, E).(Fig.28).

***Tighten hardware after that.**

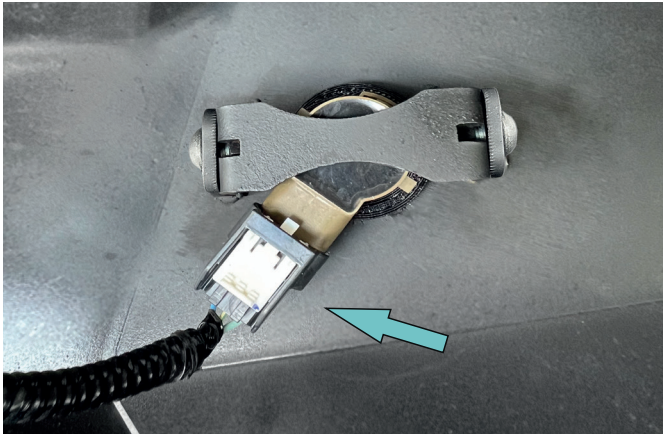

Fig. 29



Fig. 30

30. Connect OE parking sensors and LED lights with OE wiring. Fix wire using cable clips and cable tie (item K,N) (Fig. 29,30).



Fig. 31

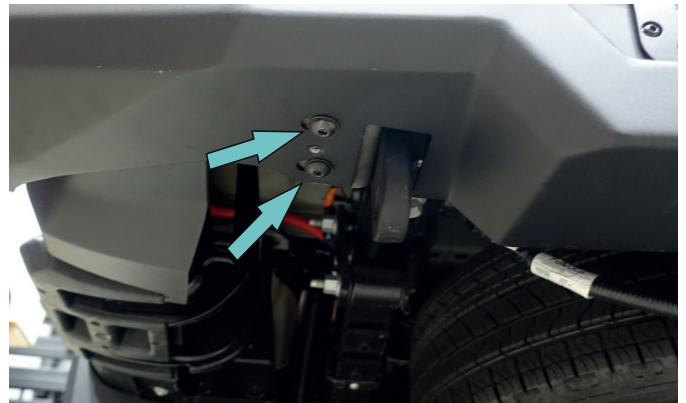

Fig. 32

31. Install bumper body (item 1) on bracket (item 2), and fix using screws M10 and washers 10 (item B,F) (Fig 31,32). Align bumper body (item 1) on the vehicle. Adjust bumper body down, if it's necessary, using adjusting plate 2mm (item 18).

***Do not tighten yet.**

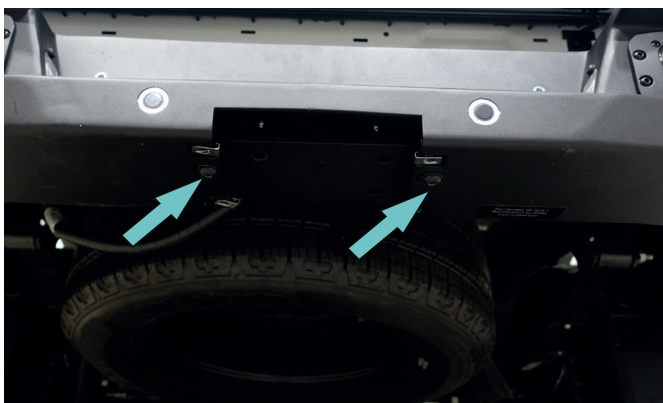

Fig. 33

32. Insert spacer (item L) between bumper body (item 1) and bracket (item 2). Fix bumper body (item 1) on bracket (item 2) using screws M10 and washers 10 (item B,F) (Fig 33).

***Tighten hardware after that (step 31,32).**



Fig. 34

33. Connect OE wiring of bumper (Fig. 34)

Follow steps 34-35 if you will not install tow hitch.

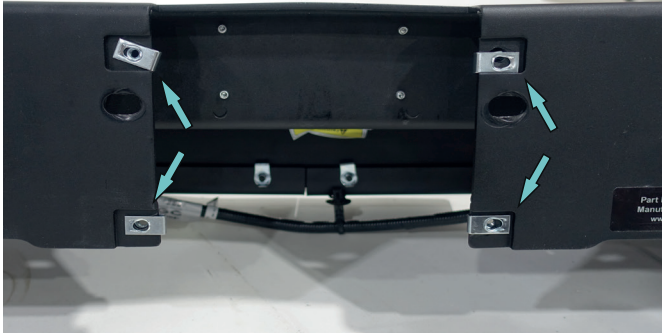

Fig. 35

34. Install U-nuts M6 (item J) on bumper body (item 1) as shown in fig.35.



Fig. 36

35. Install bottom plug (item 7) onto bumper body (item 1) using screws M6 and washers 6 (item A,E) (Fig. 36).

***Tighten hardware after that.**

Follow steps 36 if you are going to install tow hitch.



Fig. 37

36. Install the standard socket on the trailer hitch socket bracket (item 8) using the OE bolts and nut M5 (item) as shown in fig. 37.

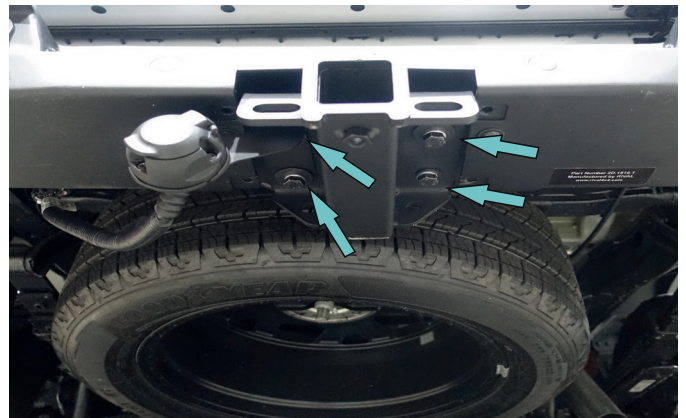

Fig. 38

37. Install tow bar square (item 9) and tow bar socket bracket (item 8) using bolts M12x1.25x40 (item D), spring washers 12 (item S) and washers 12 (item H) on bracket (item 2) as shown in fig. 38.



Fig. 39

38. Check all wires. Connect terminal “-” from the vehicle battery (Fig. 39).

Before operating a vehicle fitted with a RIVAL Bumper 2D.1816.1-NL:

- make sure all fittings are tightened
- check all electrical wiring attached to lights

