

PRODUCT: STEEL STEERING SKID PLATE

APPLICATION: JEEP WRANGLER JK  
JEEP WRANGLER JL  
JEEP GLADIATOR JT (except Mojave)

PART NO: 2111.2761.1.3



## CAUTION!

To reduce the risk of serious injury or damage to property: Before you start installing and using this product, read the full instructions, pay special attention to the conditions of safe use and recommendations for installation! When installing or maintaining this product, it is necessary to use protective goggles. Check the integrity of the structure and the moment the fastening is tightened every 250 miles (400 kms) of mileage. Do not use this product if there is damage to the structure or fasteners!

## NOTICE

Skid plate is an additional protection, but it can not guarantee to protect against all possible damage in collisions. When driving, be careful of objects and terrain that may damage sensitive parts of the vehicle.

# STEERING SKID PLATE

**RIVAL**

Part number: 2111.2761.1.3

Suited to vehicle: JEEP WRANGLER JK 2.8D, 3.6 (2007 - 2018)  
JEEP WRANGLER JL 2.0, 3.6, 2.2D (2018 - PRESENT)  
JEEP GLADIATOR JT 3.6 (except Mojave)

Material: Steel



## SAFETY NOTICE

- \* The RIVAL skid plate is designed to complement the use and design of the specified vehicle under conditions specified by the vehicle manufacturer.
- \* While driving the vehicle at any speed, collision with any other vehicle, animal or object must always be avoided.
- \* Following any collision with any other vehicle, animal or object, the RIVAL skid plate and the vehicle must be inspected by a specialized or suitably qualified vehicle repairer for possible damage to the components and assemblies in order to confirm suitability for further use of the vehicle.
- \* It is strongly recommended that you do not operate a vehicle with a damaged skid plate or its components. In the case of damage, please contact the nearest RIVAL dealer. Vehicle, or where the skid plate has been damaged, is extremely dangerous and must be avoided at all cost.

## INSTALLATION NOTICE

- \* The RIVAL skid plate must be mounted and affixed to the vehicle according to this installation manual.
- \* Personal safety during the installation process must be adhered to at all times.
- \* Do not install this skid plate on vehicle models other than those allowed in this manual.
- \* Estimated time for installation: 1 hour.

## REQUIRED TOOLS

- \* Basic tool kit
- \* Torque wrench

## TORQUE SETTING

- \* M10 - 30 H·m (22.1 lb/ft)

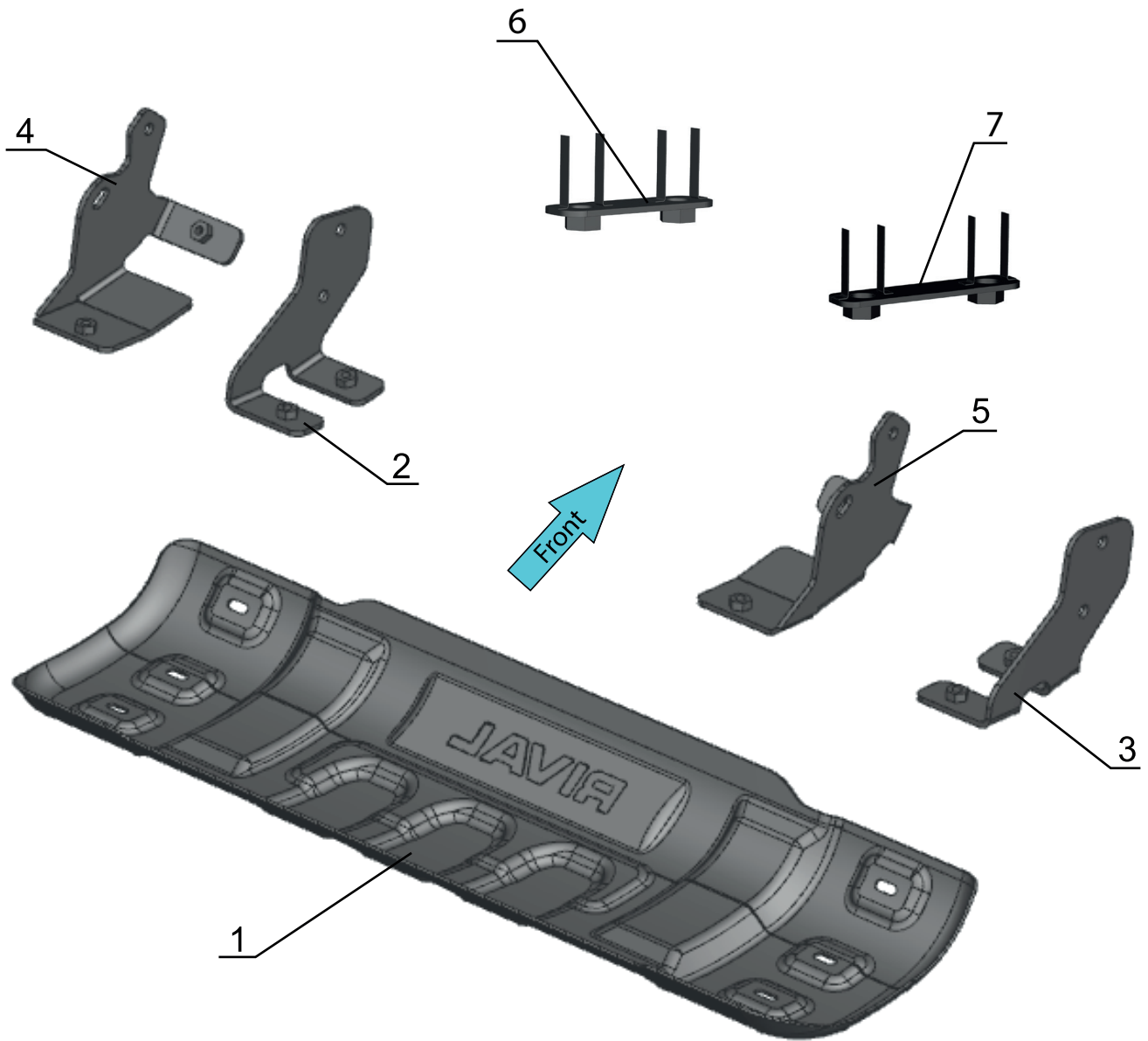

- 1. Steering skid plate.....Qty 1
- 2. Mounting bracket left JK.....Qty 1
- 3. Mounting bracket right JK.....Qty 1
- 4. Mounting bracket left JL/JT.....Qty 1
- 5. Mounting bracket right JL/JT.....Qty 1
- 6. Insert nut M10 with wires (L=95mm).....Qty 2
- 7. Insert nut M10 with wires (L=111mm).....Qty 2

A



B

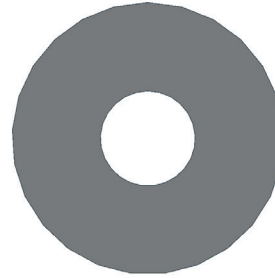

- A. Bolt M10x30.....Qty 8
- B. Washer 10.....Qty 8

# INSTALLATION PROCEDURE

# RIVAL

\*If equipped, remove the factory skid plate or any other aftermarket skid plate.

## Steps for JEEP WRANGLER JK

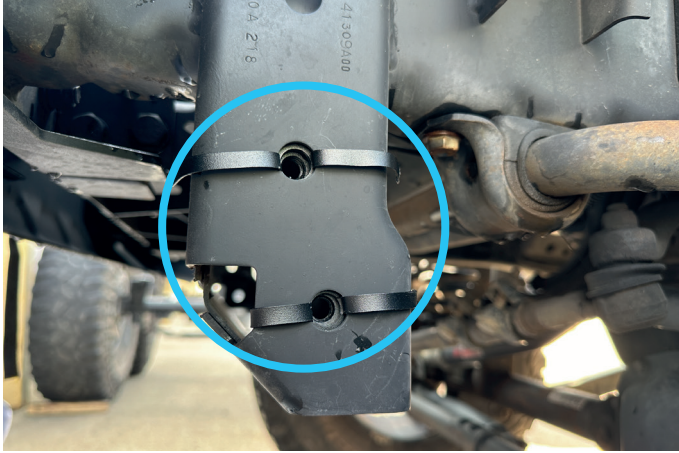

Fig. 1

1. Install insert nut M10 with wires (item 6), as shown in fig.1.

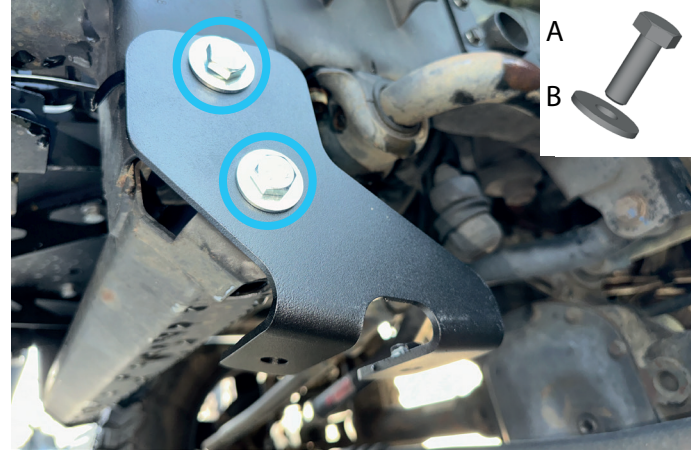

Fig. 2

2. Fix mounting bracket left JK (item 2) using bolts M10x30 (item A) and washers 10 (item B), as shown in fig.2.

**\*Do not tighten yet.**

3. Repeat steps 1,2 for right side of vehicle.

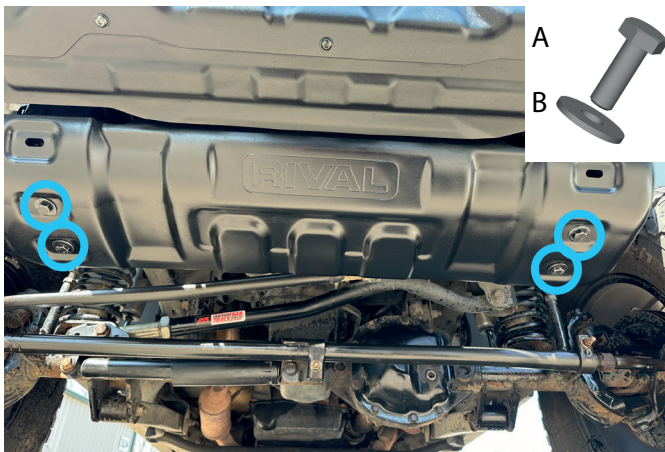

Fig. 3

4. Fix steering skid plate (item 1) using bolts M10x30 (item A) and washers 10 (item B), as shown in fig.3.

**\*Tighten hardware after that.**

## Steps for JEEP WRANGLER JL and JEEP GLADIATOR JT (except Mojave)

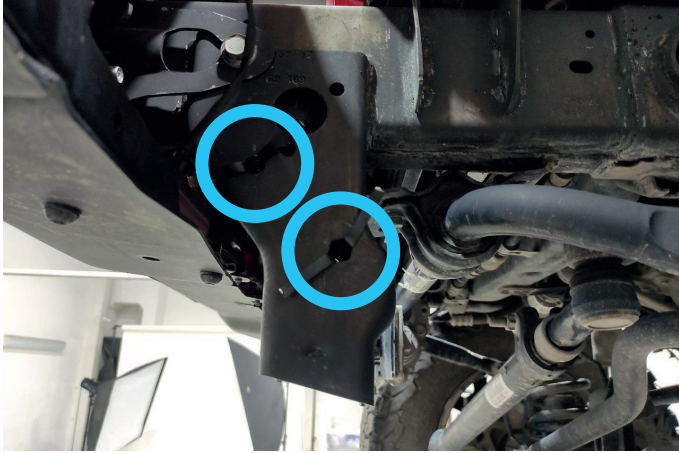

Fig. 4

5. Install insert nut M10 with wires (item 7), as shown in fig.4.

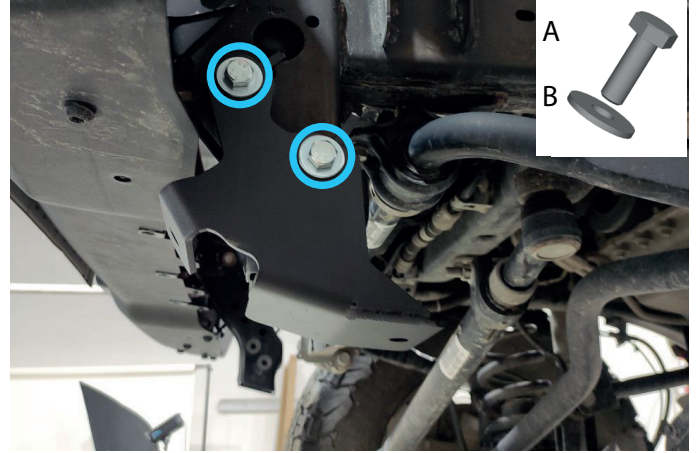

Fig. 5

6. Fix mounting bracket left JL/JT (item 4) using bolts M10x30 (item A) and washers 10 (item B), as shown in fig.5.

**\*Do not tighten yet.**

7. Repeat steps 5,6 for right side of vehicle.

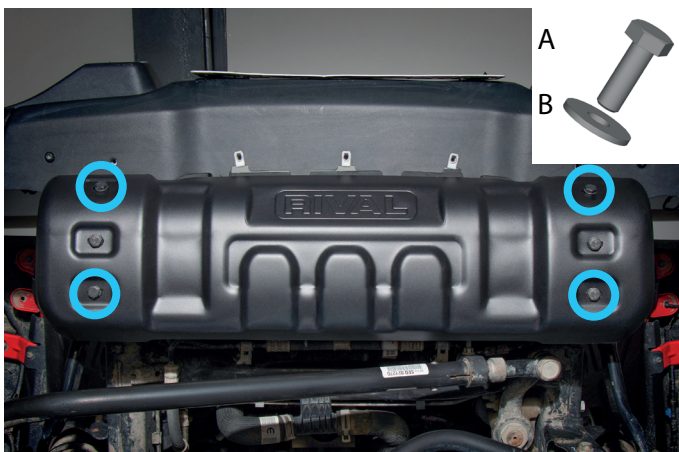

Fig. 6

8. Fix steering skid plate (item 1) using bolts M10x30 (item A) and washers 10 (item B), as shown in fig.6.

**\*Tighten hardware after that.**

Before operating a vehicle fitted with RIVAL Skid Plate:

- make sure all fittings are tightened;
- ensure the integrity of the structure and its components.

